

# Metso:Outotec

Guidelines in slurry pumping

## Slurry pump handbook



The information contained herein is general in nature and is not intended for specific construction, installation or application purposes. Predictions of actual performance of a given piece of equipment should take into account many variable field factors the machine is liable to encounter. Because of those factors, no warranty of any kind, expressed or implied, is extended by presenting the generalized data herein.

We reserve the right to make changes in specifications shown herein or add improvements at any time without notice or obligation.

# Table of contents

## Module 1: Basics

<b>1. History</b> .....	<b>5</b>	Overhead mounting - limitations .....	32
Slurry pumps – history .....	5	V-belt transmissions (fixed speed drives).....	32
Horizontal slurry pumps .....	5	V-belt transmissions – limitations.....	32
Vertical froth pumps .....	6	Variable speed drives.....	33
Vertical sump and tank pumps .....	6	Variable speed drives – limitations.....	33
<b>2. Introduction</b> .....	<b>7</b>	Comments on combustion engine drives .....	33
Hydraulic transportation of solids .....	7	<b>10. Hydraulic performance</b> .....	<b>34</b>
What are the limitations in flow? .....	8	Pump curves.....	34
What are the limitations for solids? .....	8	Head and pressure.....	39
Slurry pumps in industry.....	8	Hydraulic conditions on the inlet side.....	40
<b>3. Basic definitions</b> .....	<b>9</b>	Pumps operating on suction lift .....	43
Why slurry pumps? .....	9	Froth pumping .....	44
<b>4. Mechanics</b> .....	<b>12</b>	<b>11. Slurry pump systems</b> .....	<b>46</b>
<b>5. Slurry pump components</b> .....	<b>13</b>	General .....	46
Impeller/casing .....	13	Basic on pipe systems.....	46
The slurry pump impeller .....	13	Friction losses .....	47
Number of impeller vanes.....	14	TEL – Total Equivalent Length.....	48
Semi-open or closed impeller? .....	14	Valves, fittings, head losses .....	49
The slurry pump casing .....	17	Sump arrangements.....	51
Split or solid casings?.....	17	Multiple-pump installations.....	52
<b>6. Wear protection</b> .....	<b>18</b>	<b>12. Best Efficiency Point (BEP)</b> .....	<b>56</b>
Abrasion .....	18	Hydraulic effect of efficiency point operation....	56
Erosion.....	18	<b>13. Technical description</b> .....	<b>58</b>
Effect of erosion on pump components.....	19	General .....	58
Wear protection – what options?.....	20	Nomenclature.....	58
Selection of wear materials .....	20	Metso Outotec slurry pump series and sizes.....	59
Parameters for selection .....	20	Metso Outotec horizontal slurry pump wet-end modular configurations.....	60
Effect of particle size on material selection.....	21	Metso Outotec vertical slurry pump wet-end modular configurations.....	61
Selection of wear material – Metals.....	21	Slurry pump range MD .....	62
The elastomer families .....	23	Slurry pump range XM.....	63
Something about ceramic liners.....	23	Slurry pump range XR.....	64
<b>7. Basics of shaft sealing</b> .....	<b>24</b>	The Orion series of Heavy Duty Rubber Lined and Hard Metal slurry pumps type HR and HM.....	66
Type of leakage .....	25	The Orion series of Mining Duty Rubber Lined and Hard Metal slurry pumps type MR and MM....	67
Flushing seals.....	25	The Sala series of Vertical Tank pumps VT.....	68
Centrifugal seal limitations .....	27	The Sala series of Vertical Froth pumps VF.....	69
Dynamic seal – summary of advantages.....	27	The Sala series of Vertical Sump pumps VS.....	70
Mechanical seals .....	28	The Sala series of Vertical Sump pumps VSHM, VSHR/VSM.....	71
Slurry pumps without seals – vertical designs ...	28	<b>14. Application Guide</b> .....	<b>72</b>
<b>8. Shafts and bearings</b> .....	<b>29</b>	Selection - by solids.....	73
Transmission designs.....	29	Duties related to head and volume .....	74
Pump shafts and the SFF factor.....	29	Duties related to slurry type .....	74
Basic on bearings.....	29	Duties related to mixing .....	75
<b>9. Drives for slurry pumps</b> .....	<b>31</b>	Selection of slurry pumps - by industrial application .....	75
Indirect drives - selection of motors.....	31	Industrial segment:	
Drive arrangements.....	32		
Comments on drive arrangements .....	32		

Metallic & industrial minerals.....	76	<b>23. Types of wear .....</b>	<b>117</b>
Industrial segment: Construction.....	76	Types of wear .....	117
Industrial segment: Coal.....	77	Design of parts .....	117
Industrial segment: Waste & recycling.....	77	Wear service classification and operating limits	118
Industrial segments: Pulp & paper .....	78	Performance loss.....	119
Industrial segment: Metallurgy .....	78	Examples of worn parts from a variety of operating conditions. ....	119
Industrial segment: Chemical.....	79	<b>24. Foundations.....</b>	<b>122</b>
Industrial segment: Mining.....	79	General .....	122
<b>15. Pump sizing .....</b>	<b>80</b>	<b>25. Size reduction: Grinding .....</b>	<b>123</b>
The sizing steps .....	80	Grinding strategies.....	124
Check - for cavitation .....	84	Particle liberation .....	125
<b>16. Introduction to Metso Outotec PumpDim™ .....</b>	<b>85</b>	Grinding mills .....	125
<b>Module 2: Advanced</b>		Tumbling mills.....	125
<b>17. Motors .....</b>	<b>87</b>	Stirred mills .....	126
Frame enclosures .....	88	Vibrating mills.....	126
Insulation class .....	89	Grinding processes.....	126
Motor efficiency .....	90	Grinding processes.....	127
Service Factor.....	90	<b>26. Metso Outotec Mill Discharge (MD) pumps.....</b>	<b>128</b>
Mounting.....	90	<b>27. Dredge pumps.....</b>	<b>130</b>
Environment.....	90	Metso Outotec Hydra-Jets.....	132
Variable Frequency Drives (VFD).....	90	<b>28. Slurry transport.....</b>	<b>133</b>
Formulas .....	91	Applications .....	133
Synchronous speed and slip.....	91	Mining Industry.....	133
Examples of drives.....	92	Stone and Gravel Industry.....	133
<b>18. Noise .....</b>	<b>93</b>	Cement Industry.....	133
<b>19. Shaft seal options.....</b>	<b>94</b>	Chemical Industry .....	133
Water flush glands.....	94	Steel Works.....	133
Centrifugal sealing .....	96	Coal Industry.....	133
Mechanical seals .....	98	Slurry Pipeline sizing .....	134
Sealing type selection guide .....	100	Wear.....	136
Buffer fluid systems.....	101	Metso Outotec Hose and Lined Pipe.....	136
<b>20. Torque – Speed curves.....</b>	<b>103</b>	Examples of installations using Metso Outotec slurry hose and piping .....	138
<b>21. Vibration .....</b>	<b>106</b>	<b>29. Slurry valves .....</b>	<b>140</b>
Vibration Standards.....	107	Applications .....	140
Vibration Instrumentation .....	107	Slurry valve sizing.....	140
Vibration Levels .....	108	Metso Outotec slurry valves .....	142
Vibration levels for Metso Outotec pumps.....	109	<b>30. Miscellaneous .....</b>	<b>145</b>
Performance tracking .....	109	Conversion factors .....	145
<b>22. Viscosity .....</b>	<b>110</b>	Tyler standard scale .....	146
Rotational viscometers.....	110	Density of solids .....	147
Tube/pipe viscometers.....	111	Water and solids – Pulp density data.....	149
Pump and system calculations.....	113	<b>31. Chemical resistance tables .....</b>	<b>163</b>
Can a slurry mixture be pumped? .....	114	Elastomer materials .....	163
Slump test .....	114	High Chromium .....	165
Pencil test .....	116		

# 1. History

A summary of the rich history behind the pumps offered under the Metso Outotec brand.

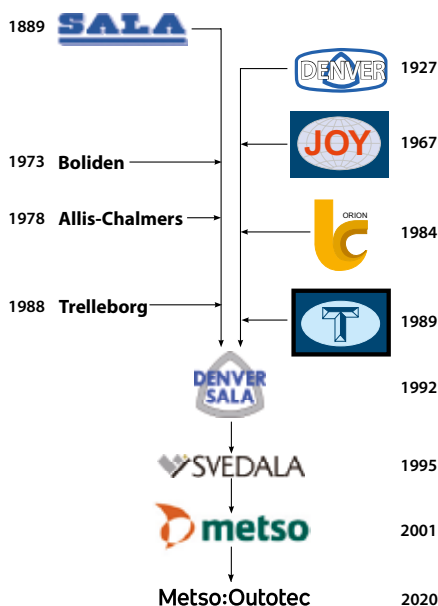

## Slurry pumps – history

Metso Outotec slurry pumps have a long history that leads to today's modern slurry pump product line. Several companies and product lines have been combined over the years. Modern research and development techniques are now used to develop the next generation of slurry pumps to carry us into the future. Two companies, Denver Equipment and Sala International and their pump product lines were the nucleus for the complete line of pumps offered today.

Both companies started as mineral process equipment manufacturers. Denver concentrating on flotation as the key product and Sala offering both flotation and magnetic separation as their major products.

Following a period of success with mineral processing equipment, it soon became very obvious that there was an urgent need to become active in the supply of slurry pumps.

When Svedala Pumps & Process was formed in 1995 it was decided to streamline and update all pump ranges in order to better serve the market with "state of the art" slurry pumps.

Svedala was acquired by Metso in 2001. A totally new range for both horizontal and vertical slurry pumps were developed which included the hard metal and rubber lined Mill Discharge pumps.

In July 2020 Metso and Outotec combined to form Metso Outotec, becoming a frontrunner in sustainable technologies, end-to-end solutions and services for the aggregates, minerals processing, metals refining and recycling industries globally.



## Horizontal slurry pumps

Slurry pumping, being the foundation of all wet mineral processing, was becoming more and more important to customers of both Denver and Sala.

Denver's answer was to take on a license for the Allis Chalmers design of the SRL (Soft Rubber Lined) slurry pump. This laid the foundation for Denver's slurry pump program for many decades and is still considered by many to be an industry standard.

In 1984 Denver acquired the Orion hard metal slurry pump range to complement the SRL product line.

The acquisition of Thomas Foundries in 1989 added a range of very large dredge and aggregate hard metal pumps to the Denver program.

In Sala's case the situation was similar. Sala's customers continued to request that slurry pumps should be supplied together with mineral processing equipment, thus providing for the first time, a complete package. The license agreement — signed by Sala was for an English design, the Vac-seal slurry pump.

In the early 1960's Sala developed a new range of medium duty slurry pumps. This range known as VASA (Vac seal - Sala) was in the late 1970's complemented with the heavy duty version VASA HD.

## Vertical froth pumps



*Denver Orion, circa 1985*

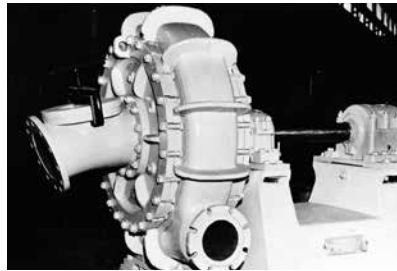

*Thomas dredge pump, circa 1948*

The use of flotation as a mineral separation method required a further development of slurry pumps. As early as 1933, a vertical "open pump" was developed in a Swedish flotation plant. This design was necessary due to the very complicated circuits that often existed in these plants.

The reagents and level control technology were not particularly advanced. Variations of froth flow in different parts of the circuit caused air blockages with conventional slurry pumps. For the first time, the "open pump" with its integral feed tank provided deaeration, stability and self regulation; properties which these days are taken for granted.

## Vertical sump and tank pumps

As many plant floors were flooded, customers also tried to develop a pump able to cope with the work of keeping the plant floor clean of slurry. Accordingly, the "sump pump" was developed.

The birth of the first operational sump pump for these clean up purposes was in the mid 1940s, again designed specifically to meet a customer need.



*The first vertical pump, manufactured 1933.*

Both the vertical tank pump and the vertical sump pump were developed within Boliden Mining Company throughout the 1940s. Sala supplied these pumps to Boliden on a subcontract basis until 1940, when Sala International signed an agreement to start production under license.

These pump lines were successfully marketed by Sala together with the VASA program. The licensing agreement ended in the early 1970s when Boliden acquired Sala.

A special vertical pump for handling froth was designed and developed which significantly refined and improved froth handling capabilities.

Throughout the years these pumps have seen continuous design and development progress. Metso Outotec's pumps are considered to have set a world-wide industry standard for others to follow.

## 2. Introduction

### Hydraulic transportation of solids

In all wet industrial processes, hydraulic transportation of solids involves different stages of solid/liquid mixing, solid/solid separation and solid/liquid separation. These wet industrial processes are further described in Chapter 16 - Application Guide.

#### What type of solids?

A solid can be almost anything that is:

Hard	Coarse
Heavy	Abrasive
Crystalline	Sharp
Sticky	Flaky
Long fibrous	Frothy

#### You name it – it can be transported hydraulically.

#### What type of liquids?

In most applications, liquid is used as the carrier fluid. In 98 % of the industrial applications, the liquid is water.

Other types of liquids may be chemical solutions like acids, caustics, alcohol, light petroleum liquids (kerosene), etc.

#### Definition of a slurry

- A mixture of solids and liquids is normally referred to as "slurry".
- A slurry can be described as a two phase fluid (liquid/solid).
- Slurry mixed with air (common in many chemical processes) is described as a three phase fluid (liquid/solid/gas).
- Slurries can be settling or non-settling and some terms describing them are:

Mud	Paste
Suspensions	Slime
Slip	Pulp
Dispersions	Broth
Silts	
Tailings	Sludge
Concentrate	Froth

## What are the limitations in flow?

In theory, there are no limits to what can be hydraulically transported. However, particle size, shape, slurry concentration, and pipe line designs can restrict flow capabilities.

In practice, the limitations in flow for a centrifugal slurry pump range from **1 m<sup>3</sup>/hour** (4.4 US gpm) up to **30 000 m<sup>3</sup>/hour** (132,000 US gpm).

The lower flow limit is determined by the efficiency drop for smaller pumps. The higher flow limit is determined by the dramatic increase of costs for large slurry pumps as compared to the use of multiple pump installations. Concentrations up to 40 % by volume of solids are typically considered to be the limit for pumping slurries using centrifugal pumps, though higher concentrations have been pumped.

Applications with high concentrations of solids, particularly those with fine particles, must be evaluated carefully, the slurry must be capable of flowing into the impeller eye for it to be pumped. Additionally the friction losses increase dramatically for high concentration slurries. At these high concentrations an alternative type of pump such as a positive displacement is often used.

## What are the limitations for solids?

The limitation for the solids is the geometrical shape and size and the risk of blocking the passage through a slurry pump.

The maximum practical size of material to be mass transported in a slurry pump is approximately **200 mm** (8").

However, individual lumps of material passing through a large dredge pump can be up to **350 mm** (14") (depending on the dimensions of the wet end passages).

Physical properties of solids to be considered in pump selection:

<i>Maximum size</i>	<i>Particle size distribution (d50 and d80)</i>
<i>Shape</i>	<i>Hardness</i>
<i>Solid density</i>	<i>Concentration (by weight or volume)</i>
<i>Abrasivity</i>	

## Slurry pumps in industry

Slurry pumps represent only 5 % of all centrifugal pumps installed in the industry. Yet, understandably, they can represent 80 % of the operating costs.

Consequently, it is very important to select and size slurry pumps to match the application. Metso Outotec is constantly developing and implementing product improvements as well as working with end users to provide equipment that increases operating efficiencies.

**The aim of this handbook is to provide guidance in the sizing and selection procedure for various slurry pump applications in order to minimize costs for hydraulic transportation of solids.**

If in doubt, contact Metso Outotec Proposal Support. This book is intended to give general advice only and should not be relied upon for detailed design. No responsibility will be accepted by Metso Outotec or our subsidiary companies for any loss or damages whatsoever in relation to this book.



## 3. Basic definitions

### Why slurry pumps?

By definition, slurry pumps are a heavy and robust version of a centrifugal pump, capable of handling tough and abrasive duties. A slurry pump should be considered to be a generic term, to distinguish it from other centrifugal pumps mainly intended for clear liquids.

### Slurry pump – name by duty

The term slurry pump, as stated, covers various types of heavy duty centrifugal pumps used for hydraulic transportation of solids. A more precise terminology is to use the classification of solids handled in the various pump applications.

**Slurry and sand pumps** cover pumping of mud/clay, silt and sand in the size range of solids up to 2 mm, (9 Mesh)

Size ranges are:

- Mud/clay minus 2 microns (<< 400 Mesh)
- Silt 2-50 microns (up to 270 Mesh)
- Sand, fine 50-100 microns (270 – 150 Mesh)
- Sand, medium 100-500 microns (150 – 32 Mesh)
- Sand, coarse 500-2000 microns (32 – 9 Mesh)

**Gravel pumps** cover pumping of shingle, gravel, and pebbles in the 2 - 64 mm (9 Mesh – 2.5") size range.

**Dredge pumps** cover pumping of solid sizes up to and above 64 mm (2.5").

### Slurry pump – name by application

Process applications also provide the terminology, typically:

**Froth pumps** define by application the handling of frothy slurries, mainly in flotation.

**Carbon transfer pumps** define the gentle hydraulic transportation of CIP (carbon in pulp) and CIL (carbon in leach) circuits.

**Sump pumps** have an established name typically used for vertical pumps operating in wet pits. They have long cantilevered shafts so that bearing housings and drives can be mounted clear of the liquid surface while the pump housing is submerged.

### Slurry pump – dry or semi dry?

#### Dry installations

Most horizontal slurry pumps are installed dry, where the drive and bearings are kept out of the slurry and the "wet end" is closed. The pumps are free standing and clear from surrounding liquid.

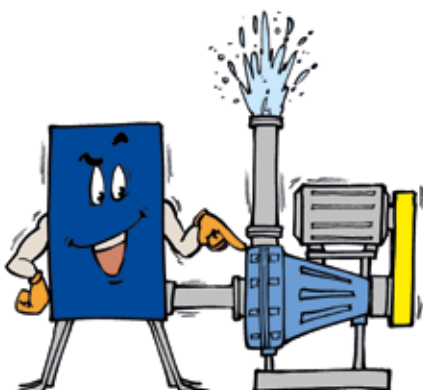

The vertical tank pump has an open sump with the pump casing mounted directly to the underside of the tank. The cantilever impeller shaft, with its bearing housing and drive mounted on the tank top, rotates the impeller inside the pump casing. The slurry is fed from the tank into the “wet end” around the shaft and is discharged horizontally from the outlet. There are no shaft seals or submerged bearings in the design.



### Semi dry installations

A special arrangement can be used for dredging applications, where horizontal pumps are used with the “wet end” (and submerged bearings) flooded. This calls for special sealing arrangements for the bearings.

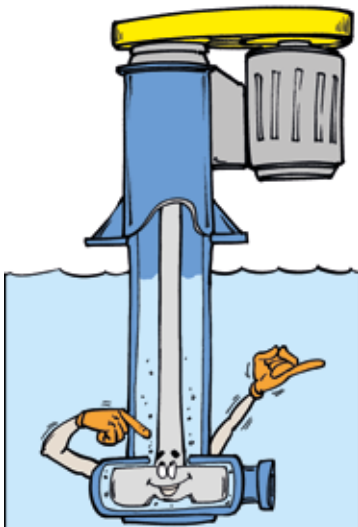
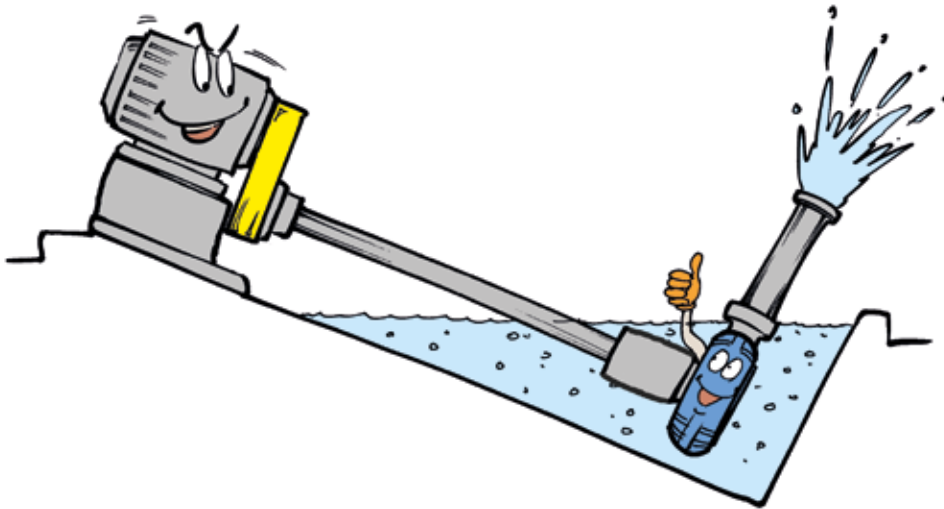

The sump pump has a flooded “wet end” installed at the end of a cantilever shaft (no submerged bearings) and a dry drive.

## Slurry pumps and wear conditions

To ensure good service performance under a variety of working conditions and applications, several factors must be considered when selecting pumps.

A primary factor is to identify the duty according to its wear service class, using the guidelines given in Hydraulic Institute Standard ANSI/HI 12.1-12.6 "Rotodynamic (centrifugal) slurry pumps."

Wear service class	Slurry class	Metso Outotec equivalent duty class
1	Light	Mildly abrasive
2	Medium	Abrasive
3	Heavy	Highly abrasive
4	Very heavy	Extremely abrasive

The Hydraulic Institute (HI) Standard recommends operating limits for these service classes. These combined with Metso's pump designs and appropriate material selections will result in optimum wear life.

Metso Outotec's PumpDim™ sizing program, in conjunction with the HI Standard, is a valuable user friendly resource for selecting pumps for specific applications.

## Type of pumps

Pumps can be classified by type. This chart gives an overview of major types and the category in which Metso Outotec slurry pumps belong.

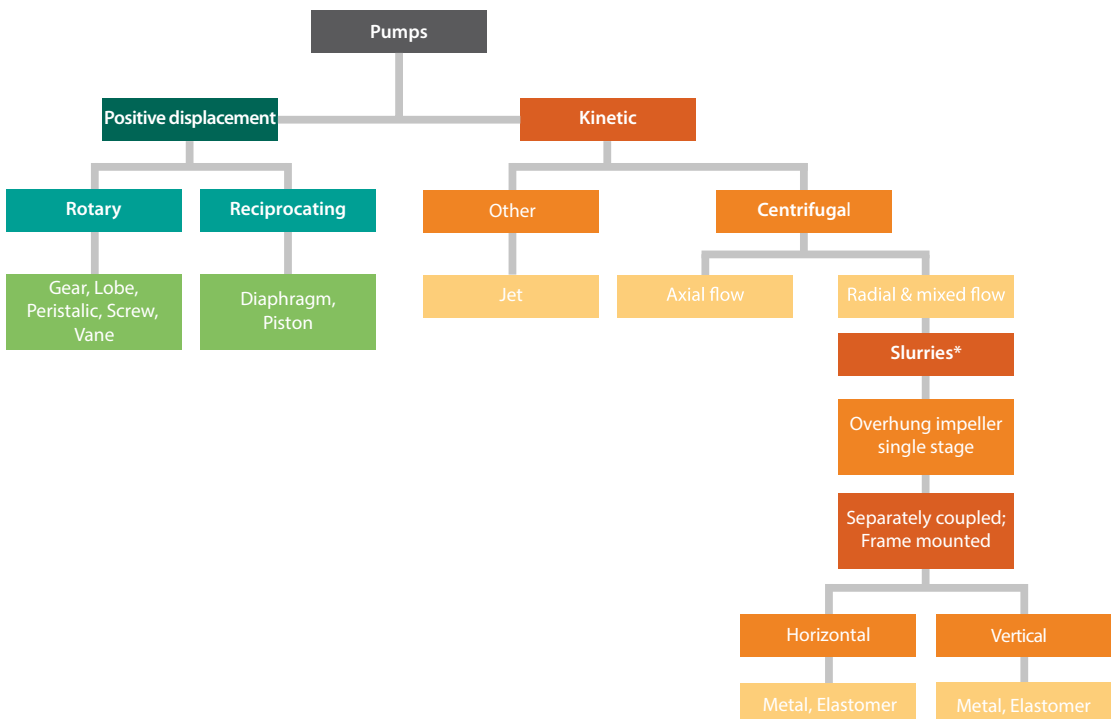

\* Ref: Hydraulic Institute ANSI/HI 12.1-12.6 definitions

# 4. Mechanics

In comparison with most other process equipment, a slurry pump is uncomplicated in design. Despite simplicity of design, there are few machines in heavy industry that work under such harsh conditions. Slurry pumps and their systems are fundamental to all wet minerals processing. Metso Outotec slurry pumps are designed with reliability in mind to allow for maximum pump availability under fluctuating conditions.

## Basic components

The basic components of all slurry pumps are the:

1. Impeller
2. Casing
3. Sealing arrangement
4. Bearing assembly
5. Drive

## Basic designs

### Horizontal pumps

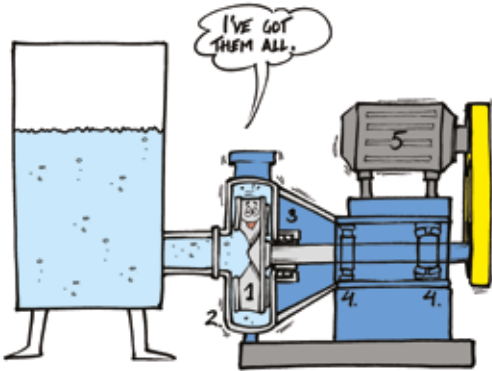

### Vertical tank pumps

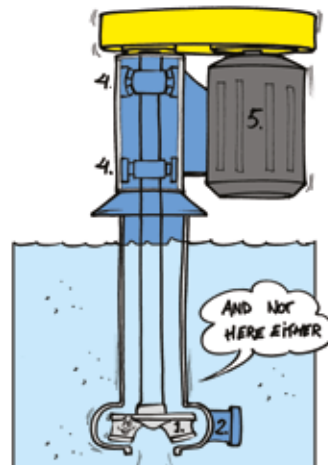
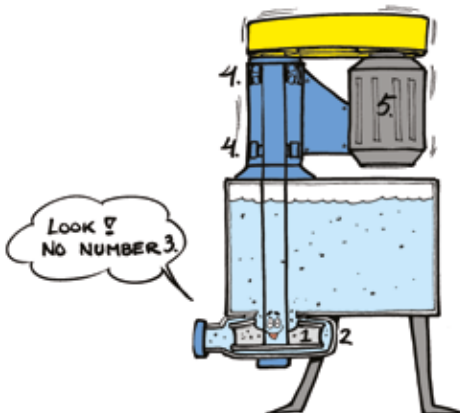

# 5. Slurry pump components

In this section, we shall look closer into the design of the various components of the slurry pump.

## Impeller/casing

### Pump impeller and casing – the key components of all slurry pumps

The performance of all slurry pumps is governed by the impeller and casing design. Other mechanical components serve to seal, support, and protect this hydraulic system of impeller and casing.

For all slurry pumps, the design principles for the hydraulic system (impeller and casing) are more or less the same; however, the design of the rest of the pump is not. The same hydraulic components can be used in vertical and horizontal designs.

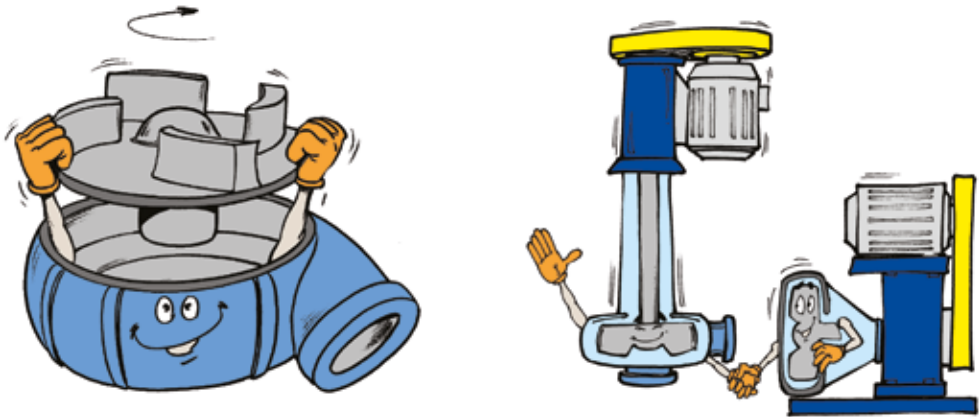

## The slurry pump impeller

Without understanding the function of a slurry pump impeller, we will never understand why and how a pump is designed and functions.

- The impeller is an energy converter.
- The function of the rotating impeller is to impart kinetic energy to the slurry mass and accelerate it.
- A part of this kinetic energy is subsequently converted to pressure energy before leaving the casing.
- The impeller vanes are the heart of the impeller. The rest of the impeller design is there to carry, protect, and balance the impeller vanes during operation.

### Vane designs

Slurry pump impellers have external and internal vanes.

#### External Vanes

These vanes also known as pump out or expelling vanes are shallow and located on the outside of the impeller shrouds. They aid efficiency by providing axial thrust balance, minimizing recirculation, and improving pump sealing.

#### Internal vanes

Commonly known as the main vanes, these actually pump the slurry. Typically, two types of main vane designs are used in slurry pumps.

## When to use Francis or Plain?

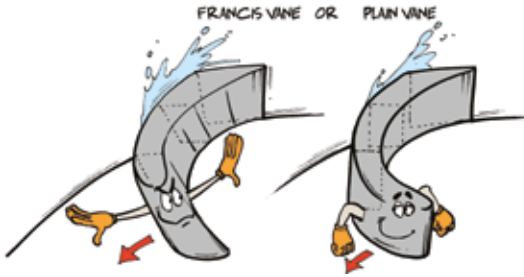

Francis vanes are more energy efficient and typically have superior wear life compared to plain vanes. However, the design of the Francis vanes makes them more complex to manufacture, which is why they are primarily utilized for cast metallic impellers only.

Plain vanes are easier to manufacture and are less sensitive to large particles frequently seen in dredge pumping applications.

## Number of impeller vanes

More vanes give higher efficiency. This means that the maximum number of vanes is always used whenever practical.

Vane thickness is necessary for good wear life. The number of vanes and thickness is determined by the need to pass a required particle size.

In practice, 5 or 6 is the maximum number of vanes, in metal impellers with diameters exceeding 300 mm (12") and in elastomer lined impellers exceeding 500 mm (20").

Below these diameters, the vane flow passage area relative to the impeller eye area becomes critical, efficiency starts to drop (reduced flow area results in high friction losses), and blockages in flow passages can also occur. Therefore, fewer than five vanes are often used.

Vortex and fully recessed induced flow impeller designs may have as many as 9 vanes.

For impellers larger than 2,000 mm (80") in diameter, a 6 vane design is used as an optimal balance between efficiency and coarse size capability.

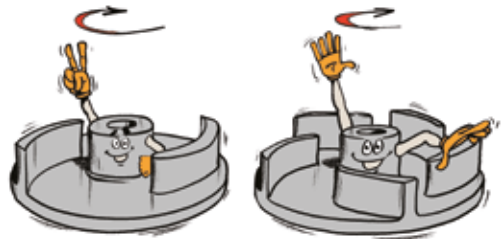

## Semi-open or closed impeller?

The design of the slurry pump impeller is not related to a closed or open configuration. This is determined by production aspects and what type of applications the impeller will be used on.

## Closed impellers

Closed impellers are by nature more efficient than open impellers, due to the reduction of short circuiting leakage over the vanes. The efficiency is less affected by wear. If efficiency is the primary design concern, use a closed impeller whenever possible.

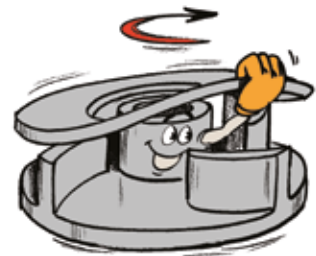

## Limitations

The closed impeller with its confined design is naturally more prone to clogging when coarse particles are encountered. This phenomenon is more of a concern with smaller impellers.



## Semi-open impellers

Semi-open impellers have a single back shroud which, compared to closed impellers of equivalent diameter, increases the passageways and, particularly on smaller sizes, simplifies the manufacturing process. As an example, this design could be used to pump fluids with entrained air, higher viscosities, and elongated fibrous material. The efficiency is slightly lower than for closed impellers.



## Induced flow impellers

Induced flow (vortex) impellers are used if impeller blockage is critical; when particles are fragile; or for non-clog pumping of stringy, fibrous, or coarse solids.

The impeller is pulled back in the casing. Only a limited volume of the flow is in contact with the impeller giving gentle handling of the slurry and large solids capability.

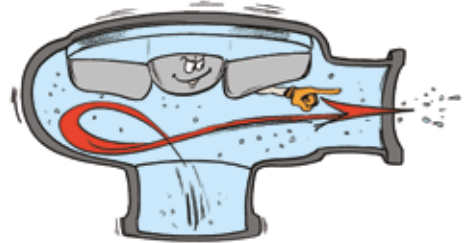

## Fully recessed impellers

The impeller is pulled completely back into the casing and provides the ultimate in large particle passing. This type of wet-end is used where material contact with the impeller needs to be minimized.

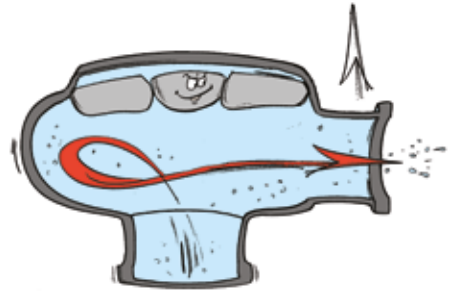

### Limitations

Induced flow impellers have efficiencies significantly lower than that for closed or even semi-open impellers.

## Basic rules

**Closed impellers** are used for slurries with coarse particles for highest efficiency and best wear life – check maximum solids size.

**Open impellers** are used for slurries with high viscosity, entrained air, and when blockage problems can be foreseen.

**Induced flow impellers** are used for large, soft solids, stringy materials or for “gentle” handling, or fragile particles, high viscosity, and entrained air.

## Impeller diameter

The impeller diameter governs the amount of head produced at a given speed.

A large diameter impeller running at slow speed would produce the same head as a smaller impeller running much faster (key aspect when it comes to wear, see Chapter 6 – Wear Protection).

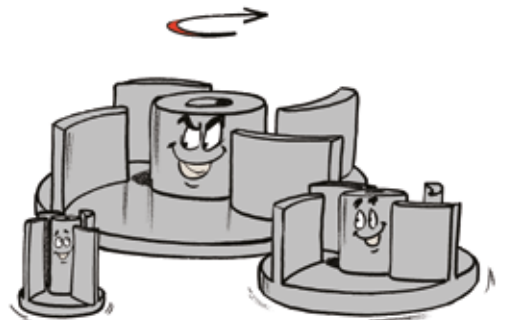

## What will be the correct diameter?

The factors that have guided Metso Outotec in this respect are:

- For highly abrasive duties, we want a **long wear life and reasonable efficiency**.
- For abrasive and mildly abrasive duties we want **reasonable wear life and high efficiency**.

### To make it simple:

For highly abrasive duties, we use large impellers giving long life and reasonable efficiencies. So even if larger impellers are more expensive and have slightly lower efficiency, they give a better pay off in highly abrasive duties.

For abrasive duties where wear is not the primary concern, smaller impellers are more economical and offer better efficiency.

This relationship is known as:

**IMPELLER ASPECT RATIO (IAR)** = Impeller diameter/Inlet diameter;

and corresponds, as shown below, to the Wear Service Class given in Hydraulic Institute Standard ANSI/HI 12.1-12.6:

Wear service class	Slurry class	Metso Outotec's equivalent duty class	IAR Impeller Ø/Inlet Ø
1	Light	Mildly abrasive	≤ 2:1
2	Medium	Abrasive	2:1
3	Heavy	Highly abrasive	2.5:1
4	Very Heavy	Extremely abrasive	≥ 2.5:1

The above parameters have been considered in the design of Metso Outotec slurry pumps to minimize operating costs in a wide variety of applications.

## Impeller width

The width of the impeller governs the flow of the pump at any speed.

A wide impeller running slowly could produce the same flow rate as a narrower impeller running faster. But most important - the velocity relative to vane and shroud would be considerably higher (a key aspect when it comes to wear, see Chapter 6 – Wear Protection).

### Remember:

Compared to water pumps and depending on the wear profile, slurry pumps normally have impellers that are not only larger, but much wider.

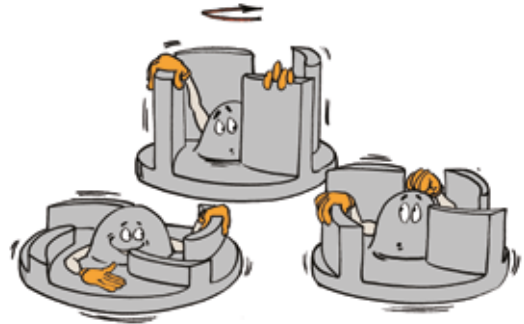

## Limitations in geometry and why?

Naturally there are various practical limits for the geometry of slurry pump impellers. In a comprehensive product range these limits are set by:

- The optimal hydraulic performance of each pump size
- The need for product standardization
- The production cost for the impeller and casing/liner

## The slurry pump casing

One function of the casing is to collect the flow discharging from the impeller, converting it into a desirable flow pattern, and directing it to the pump outlet. Another important function is to reduce the flow velocity and convert its kinetic energy to pressure energy at the discharge connection.

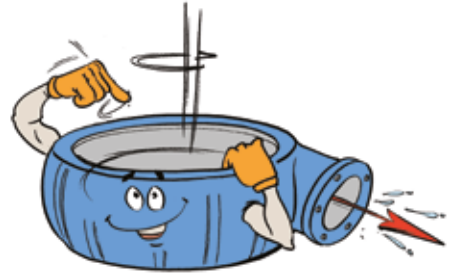

## What about the shape of the casing?

The casing and the impeller are matched together to give the best flow pattern (and energy conversion) possible.



Volute



Semi-Volute

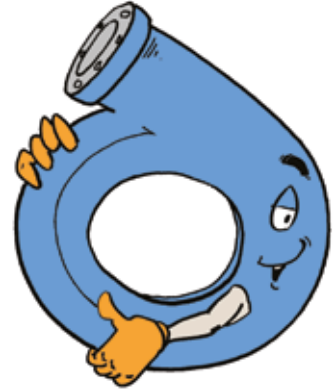

Concentric

## Volute casing

The volute form gives more efficient energy conversion compared to the concentric form and around the ideal flow/head duty point it causes very low radial loads on the impeller.

## Split or solid casings?

### Solid casing

For most hard metal pumps, the volute is normally in one solid piece. This design is the most cost effective in manufacturing and there are no practical requirements for splitting the volute into two halves.

Some elastomer lined pumps also use a solid volute, especially for the smaller sizes, where it is more practical and economic to use a solid volute.

### Split casing

Splitting a casing adds expense to a pump and is only done when necessary. This eases replacement of parts particularly for larger elastomer lined pumps.

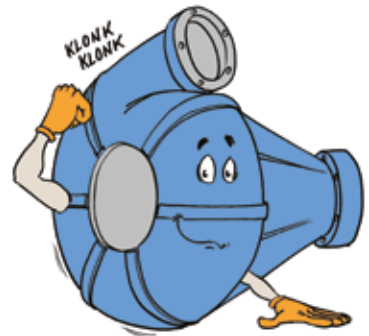

## 6. Wear protection

In a slurry pump, the wet end wear parts are always exposed to the slurry and have to be protected against wear.

Material selection for impeller and casing is just as important as the pump selection itself.

**There are three different conditions that create wear in a slurry pump:**

1. Abrasion
2. Erosion
3. Corrosion

### Abrasion

There are three major types of abrasion:

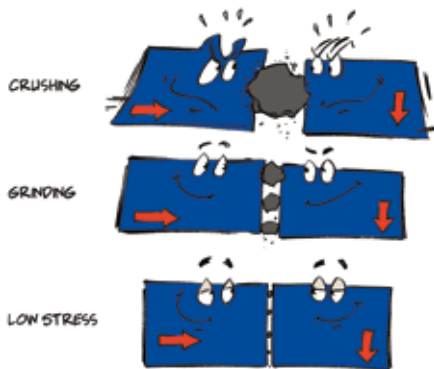

**Abrasion only occurs in two areas in a slurry pump**

1. Between impeller and the stationary inlet
2. Between shaft sleeve and the stationary packing

In slurry pumps, we have mainly grinding and low stress abrasion. Abrasion rate is dependent on particle size and hardness.

### Erosion

This is the dominant wear in slurry pumps. The reason is that particles in the slurry hit the material surface at different angles.

Erosion wear is heavily influenced by how the pump is operated. Erosion wear is, in general, at a minimum at the BEP flow rate, and increases with lower as well as higher flows. See Chapter 12 - Best Efficiency Point (BEP) section.

For reasons that are not well understood, erosion wear can also increase dramatically if the pump is allowed to operate on "snore"; that is, taking air into the inlet pipe. See page 51 for sump design.

There are three major types of erosion:

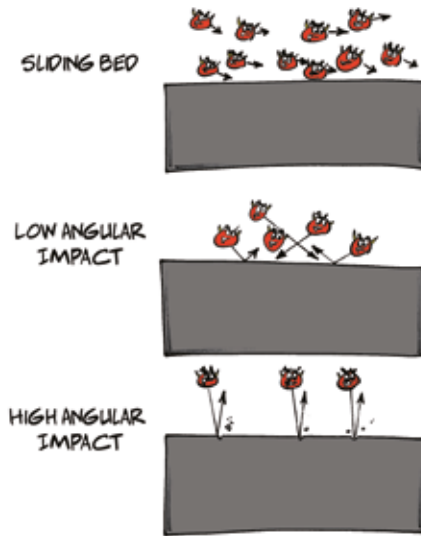

## Effect of erosion on pump components

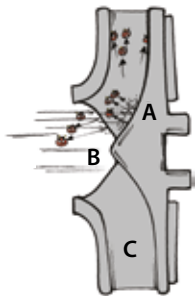

The impeller is subject to **impact wear (high and low)** mainly in the eye, on the gland side shroud (A), when the flow turns 90°. On the leading edge of the vane (B).

**Sliding bed and low angular impact** occur along the vanes between the impeller shrouds (C).

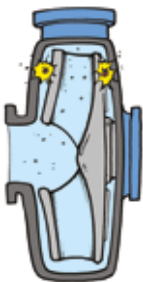

### Side liners (inlet and back liners)

Side liners are subject to **sliding bed** and **crushing and grinding abrasion**.



### Volute

The volute is subject to **impact wear** on the cut water. **Sliding bed** and **low angular impact wear** occurs in the rest of the volute.

## Corrosion

The corrosion (and chemical attacks) of the wet parts in a slurry pump is a complex phenomenon both for metal and elastomer material. Corrosion and erosion can operate together to multiply the overall effect.

For guidance, chemical resistance tables for metals and elastomer material are given on pages 22 and 23.

## Wear protection – what options?

Major options available in selecting wear protection materials:

- Impeller and casing in hard metal in various white iron and steel alloys
- Elastomer lined impeller and casing protected with elastomer liners. Elastomers normally available in various grades of rubber or Polyurethane
- A combination of hard metal impeller with elastomer lined casing

## Selection of wear materials

The selection of wear protection materials is a balance between resistance to wear and ability to manufacture parts cost effectively.

There are two strategies for resisting wear:

1. The wear material has to be hard to resist cutting action of impinging solids.
2. The wear material has to be elastic to be able to absorb the shocks and rebound of particles.

## Parameters for selection

The dominant wear materials in slurry pumps are **hard metal and soft elastomers**. Metso Outotec supplies a wide range of optional materials for both.

The selection of wear parts is normally based on the following parameters:

- Solid size (solid S.G., shape, and hardness)
- Slurry temperature
- pH and type of chemicals
- Impeller speed: which is typically limited according to the Wear Service Class as recommended in HI Standard ANSI/HI 12.1-12.6

See the table on next page for general guidance.



## Effect of particle size on material selection

Particle size		Tyler standard Sieve series	Particle description	General pump classification	
inch	mm	Mesh size			
>3	>76.2		Cobbles		Dredge pumps
3	76.2				
2.5	63.5				
1.5	38.1				
1.05	26.7				
0.883	22.43				
0.742	18.85				
0.624	15.85				
0.525	13.34				
0.441	11.20				
0.371	9.42				
0.312	7.92	2.5	Screen		
0.265	6.73	3	Shingle	Rubber-lined pumps; closed impeller: round particles	Gravel pumps
0.233	5.92	3.5	Gravel		
0.187	4.75	4	Pebbles		
0.157	3.99	5			
0.132	3.35	6			
0.111	2.82	7			
0.0937	2.38	8			
0.0787	2.00	9			
0.0661	1.68	10			
0.0555	1.41	12			
0.0469	1.19	14			
0.0394	1.00	16	Very coarse sand	Rubber-lined pumps; closed impeller:	
0.0331	0.841	20			
0.0278	0.706	24			
0.0234	0.594	28			
0.0197	0.500	32	Coarse sand		Slurry and sand pumps
0.0165	0.419	35			
0.0139	0.353	42			
0.0117	0.297	48			
0.0098	0.249	60			
0.0083	0.211	65	Medium sand		
0.0070	0.178	80			
0.0059	0.150	100			
0.0049	0.124	115			
0.0041	0.104	150			
0.0035	0.089	170	Fine sand	Polyurethane-lined pumps; Rubber-lined pumps, open Impeller.	
0.0029	0.074	200			
0.0025	0.064	250			
0.0021	0.053	270			
0.0017	0.043	325	Very Fine sand		
0.0015	0.038	400			
	0.025				
Note:	0.020		Silt		
1 mm =	0.010				
1000 µm	0.005		Mud clay		
	0.001				

Table 1 Classification of pumps according to solid particle size (Sand hardness particles).

## Selection of wear material – Metals

Metal is generally more tolerant to abuse than rubber and is the best choice for coarse materials. Commonly used metals are:

### High chromium irons

#### High chromium white iron (Metso Outotec GPS800 and GPS805)

Standard material for most pump ranges with a nominal hardness of 650 Brinell Hardness Number (BHN). Can be used at pH values down to 3.5 depending on chloride content. **30 % chromium white irons (Metso Outotec GPS830)** is used for more corrosive applications, see figure on next page.

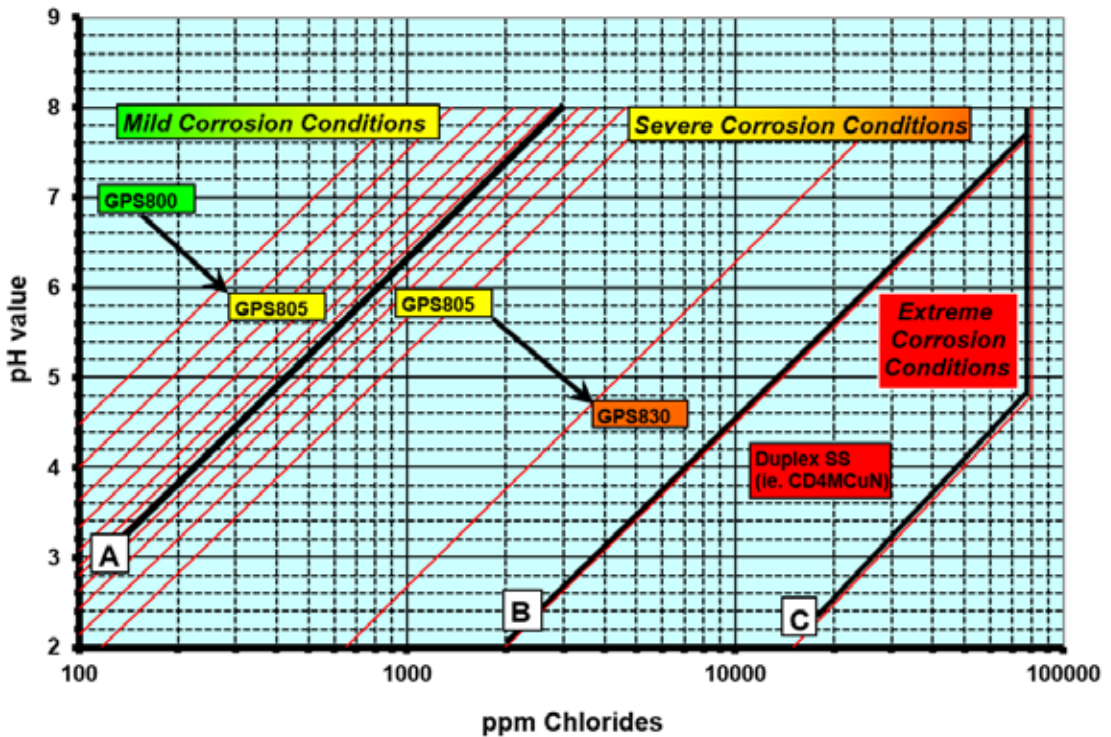

## Alloy selection chart for corrosion applications

1. Black lines A, B, and C define main corrosion levels.
2. There is NO sharp boundary between average and high corrosion, thus the same material can be used on either side of line A, depending on presence of other ions besides Cl ions.
  - a) If no other ions are present, use lower chromium material (Metso Outotec GPS800 and GPS805).
  - b) If Sulfate and/or Phosphate ions are present ( $50 < \text{ppm} < 2000$ ), then use the higher chromium content material (Metso Outotec GPS830).
  - c) For either Sulfate and/or Phosphate ions  $> 2000$  ppm, refer to Metso Outotec.

## Selection of wear material – Elastomers

Natural rubber is by far the most widely used elastomer in slurry pumping. It is the most cost effective solution for fine solids. Generally, depending on their sharpness and density, particle sizes of up to 5-8 mm can be pumped before the rubber is cut by the solids.

### Warning!

Oversize scrap and sharp particles can destroy the wear parts, especially the impeller.

## The elastomer families

### Natural rubbers

Metso Outotec's natural rubber grades are:

**Code 110** Soft liner material

**Code 168** High strength impeller/liner material

These materials come as standard materials for different pump ranges.

### Synthetic rubbers

Metso Outotec offers chlorobutyl rubber as our synthetic rubber option as per the table below.

### Polyurethanes

There are different types of polyurethanes, both ester and ether based. The comparison between polyurethanes should be done with great care. Metso Outotec uses a special ether-type of polyurethane.

Polyurethane is available for most pump ranges and offers excellent wear resistance for finer particles (<0.15 mm (100 Mesh)), but it is at the same time less sensitive to oversized scrap than rubber. It has its peak performance in low angular impact and sliding wear. It is commonly used in flotation circuit pumps when oil or hydrocarbon reagents are used.

The table below can be used as a general guide for elastomer selection.

Material	Wear resistance	Chemical properties			Thermal properties	
		Diluted acids	Strong acids	Oils, hydrocarbons	Highest service temp. °C (°F)	
					Continuously	Occasionally
Natural rubbers	Excellent	Good	Poor	Poor	65 (149)	75 (167)
ChloroButyl	Good	Excellent	Good	Good	80 (176)	100 (212)
Polyurethane	Very good	Fair	Poor	Good	50 (122)	65 (149)

For exact data on chemical resistance, see tables in chapter 31.

## Something about ceramic liners

Although ceramic has a high resistance against wear, temperature, and most chemicals, it has never really been accepted as a day-to-day standard in slurry pumping.

Being both brittle and expensive to manufacture, development work on ceramic continues in an attempt to improve its acceptability.



# 7. Basics of shaft sealing

If the impeller/casing designs are principally the same for all of our slurry pumps, this is definitely not the case when it comes to the seals for these hydraulic systems.

## Critical parameters for the selection of seals

**Horizontal:** Slurry leakage (flooded suction), air leakage (suction lift), shaft deflection, and inlet head.



**Vertical:** Designed without shaft seals.

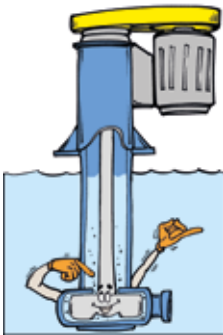

## Shaft seals

- Where the shaft passes into the casing, leakage (air or slurry) is prevented by the use of various shaft seals
- The shaft seal has a very important function in any slurry pump
- The selection of the correct seal for any application is essential

## Basic function of shaft seal

The basic function of a shaft seal is quite simple. To plug the hole in the casing where the shaft passes through, thereby restricting (if not stopping) leakage.

## Type of leakage

With flooded suction, leakage is generally liquid leaving the pump, whereas, on a suction lift leakage can be air entering the pump.

### Location and type of seals

Seals are located in a housing or stuffing box. Three basic designs are available:

1. Soft packing (Soft packed gland) seal
2. Mechanical seal (spring loaded flat faces)
3. Dynamic seal



## Flushing seals

For most slurry pumps, the flushing liquid is clear water. To provide the best possible sealing life, the water should be of good quality without any solid particles.

Where some slurry dilution is acceptable, soft packing seals are normally the first choice with two options:

**Full flow flushing type** when dilution of slurry is no problem.

Typical flushing quantities for full flow depend on pump size: 10-90 liters/min (2.6-23.8 USgpm).

**Low flow flushing type** when minor dilution of slurry is acceptable.

Typical flushing quantities for low flow depend on pump size: 0.5-10 liters/min (0.13-2.6 USgpm).

**Note:** The full flow soft packing option (when applicable) normally provides the longest seal life for slurry pumps.



Full Flow



Low Flow

Flush gland configurations are economical and easier to service, provided external flush fluid leakage is acceptable.

### Seals without flushing

In order to provide a reliable seal without flush water, centrifugal (expeller) seals or mechanical seals can be used.

### Centrifugal seals

An expeller used in conjunction with a packed stuffing box is described as a centrifugal seal. Centrifugal seals have been around for many years, however design and material technology have advanced to the point where a high proportion of slurry pumps now supplied incorporate an expeller.

The centrifugal seal is only effective when the pump is running. When the pump is stationary, static sealing is provided by conventional shaft packing, although fewer packing rings are used.

### Expeller - description

The expeller is in effect, a secondary impeller positioned behind the main impeller with its own seal chamber close to the main pump casing.



Operating in series with the impeller back shroud pump out vanes, the expeller prevents the liquid from leaking out of the stuffing box, ensuring a dry seal.

This dry seal is achieved because the total pressure produced by the pump out vanes and the expeller, is greater than the pressure produced by the main pumping vanes of the impeller plus the inlet head.

Stuffing box pressure, with a centrifugal seal, is therefore reduced to atmospheric pressure.



## Centrifugal seal limitations

All centrifugal seals are limited in the amount of inlet head they can seal relative to the operating pump head.

The limit for acceptable inlet head is, in the first instance, set by the ratio of expeller diameter to impeller main vane diameter.

Most expellers, depending on the design, will seal inlet heads up to 10 % of the operating discharge head for standard impellers.

Higher inlet heads may be sealed by changing the expeller/impeller main vane diameter ratio. If in doubt, contact Metso Outotec Proposal Support.

Exact calculations are also done by our pump sizing and selection software.

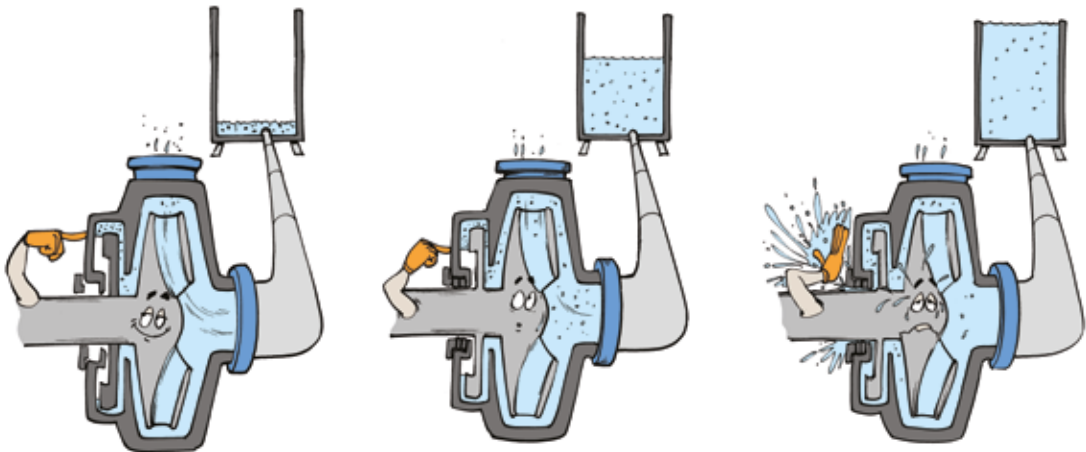

Exceeding the inlet head limits will increase pressure on the seal to the point where leakage occurs.

With the pump stationary, the packing will see pressure from both inlet and discharge pipes and slurry will leak out unless the pump is protected by isolating valves.

## Dynamic seal – summary of advantages

- No flush water required
- No dilution by flush water
- Reduced maintenance of packings
- Zero gland leakage during operation

## Mechanical seals

Mechanical seals must be considered in cases where dynamic expeller seals are not possible (see limitations above).

These are high precision, water lubricated, water-cooled seals running with such tolerances that slurry particles cannot penetrate the sealing surfaces and destroy them.

Mechanical seals are very sensitive to shaft deflection and vibration. A rigid shaft and bearing arrangement is crucial for successful operation.

If the mechanical faces are not submerged in liquid, friction between the sealing surfaces will generate heat, causing the faces to fail within seconds. This can also happen if the impeller pump out vanes are too effective.

Metso Outotec offers cost effective and reliable mechanical seals in several configurations for slurry applications. Development efforts to improve designs and reduce costs are an on-going process.

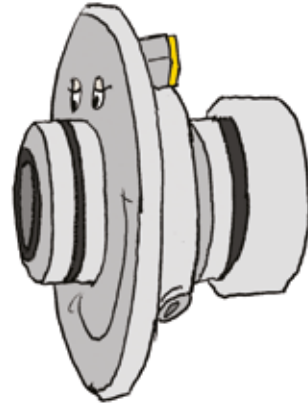

## Slurry pumps without seals – vertical designs

The two main reasons for development of the vertical slurry pumps were:

1. To utilize standard electric motors, mounted in a dry location
2. To eliminate sealing problems

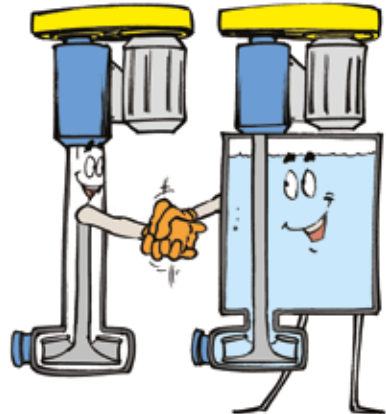

# 8. Shafts and bearings

## Transmission designs

Impellers are supported on a shaft which is in turn carried on antifriction bearings. Bearings are generally oil or grease lubricated.

In our slurry pumps which are of a single-stage design, the impeller is always mounted at the end of the shaft (overhung design).

Drive to the shaft is normally via belts and pulleys or a flexible coupling (with or without a gearbox).

## Pump shafts and the SFF factor

As the impellers of slurry pumps are subject to higher loads than clean-water pumps, it is essential that the shaft is of robust design.

SFF, Shaft Flexibility Factor (also known as slenderness ratio or stiffness ratio), relates the shaft diameter at the shaft seal  $D$  to the overhung length (from the wet end bearing to the impeller center line)  $L$  and, in a simplified form, is defined as  $L^3/D^4$ .

This is a measure of the susceptibility to deflection (which is critical to shaft sealing and bearing life).

Typical SFF values for horizontal slurry pumps are 0.2 – 0.75 in the metric system, the equivalent for the inch system being 5 - 19.

Horizontal pumps for clean liquids typically have SFF values of 1 – 5 (25 - 125) and could even be significantly greater.

The type of process and the duty conditions to which a pump is subjected affects the selection and sizing of pumps. SFF is just one of the important comparison criteria used by engineers when evaluating pumps from different manufacturers.

**Note: Shaft deflection occurs in both horizontal and vertical slurry pumps although the longer the overhang the greater the deflection for the same radial load.**

## Basic on bearings

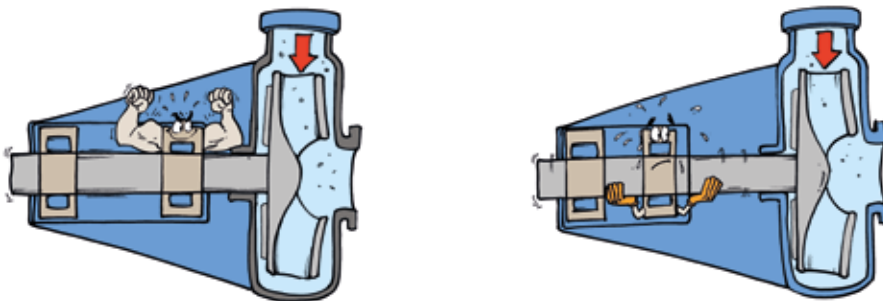

### $L_{10}$ life

Bearing life is calculated using ISO 281 (Standard for the calculation of bearing ratings and life) method. The  $L_{10}$  life is calculated in revolutions. This is the number of hours in which 10 % of bearings operating under the conditions would be expected to fail.

The average life is approximately four times the  $L_{10}$  life.

Industry practice is to refer to bearing life in hours:  $L_{10h}$ , where,  $L_{10h} = [L_{10} / (\text{Pump Speed in rpm} \times 60)]$ .

Most Metso Outotec slurry pumps bearings are sized for a minimum  $L_{10h}$  life of 40,000 hours (i.e. 160,000 hours average life).

The Hydraulic Institute Standard lists bearing lives based on service class as summarized in the table below.

Slurry service class	Minimum calculated bearing fatigue life ( $L_{10}$ life in hours)
1	17500
2	35000
3	50000
4	50000

Metso Outotec applications engineers take into account service and duty conditions provided by the user so that pumps will be selected for optimum performance; see examples given in bearing configuration paragraph below.

Users must be aware that improperly maintained bearings will fail much sooner and their life will be further reduced if contaminated by slurry. The  $L_{10h}$  life is a statistical lifetime based on the speed and load carried by the bearing. Most bearings fail through mechanisms other than fatigue such as lubrication failure, contamination or spalling.

### Bearings and bearing arrangements

In a slurry pump, both radial and axial forces act on the shaft and the bearings.

Selection of bearings and their configurations depends on the duty conditions.

#### The first arrangement:

Uses a bearing at the wet end taking up radial forces only and a bearing at the drive end taking up both axial and radial forces.

#### The second arrangement:

Uses taper roller bearings in both positions to take up axial and radial loads.

#### The vertical arrangement:

Vertical pumps with extremely long shaft overhangs use this arrangement.

### Bearing configurations

#### Radial loads

On duties such as filter press filling and pressurizing, where low flow rates at high heads are encountered, impeller radial loads are high. Double wet end bearing arrangements are utilized to give  $L_{10h}$  bearing lives well in excess of 40,000 hours (i.e. 10 % failure in 40,000 hours).

On belt driven units, dry end bearings see radial loads from belt tension forces.

#### Axial loads

On duties such as multistage series pumping where each pump immediately follows the other (i.e. pumps are not spaced down the line), high axial loads are encountered due to the high inlet head on the second and subsequent stages. To meet the minimum bearing life requirement, double dry end bearings may be required. See Chapter 12 - Best Efficiency Point for more details on axial loads.

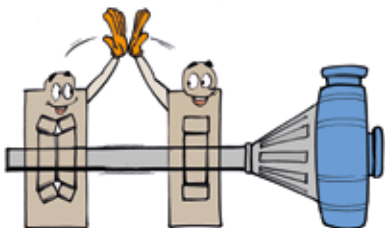

The first arrangement

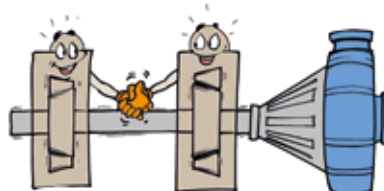

The second arrangement

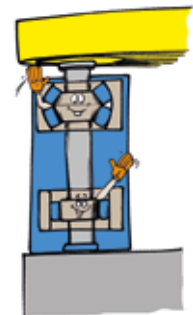

The vertical arrangement

## 9. Drives for slurry pumps

There are two basic drive designs for slurry pumps:

1. Indirect drives used for horizontal and vertical pumps comprising of a motor and a transmission. Power can be transmitted using V-belts (also known as wedge belts) or through a gearbox.

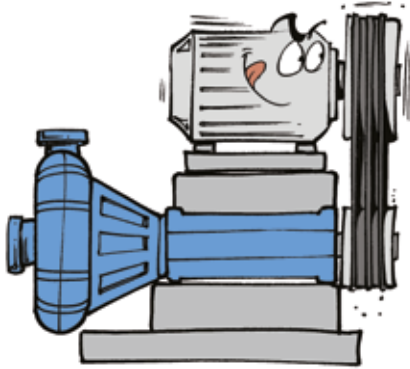

This concept gives freedom to select low cost (4-pole) motors and drive components according to local industry standards. Good flexibility is also provided for altering the pump performance by a simple speed change.

2. Direct drives are used as applications dictate on horizontal and vertical pumps. This approach can limit the ability to change pump performance because, depending on the number of poles, the motor will run at a fixed speed.

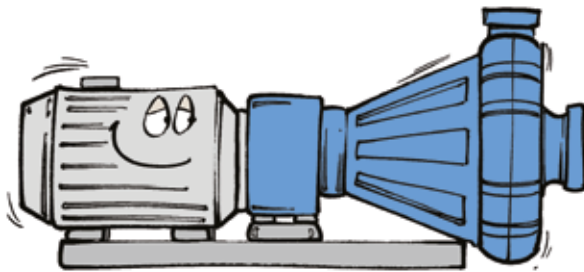

A motor with a Variable Frequency Drive (VFD) can provide more flexibility to change performance, see page 33 on Variable speed drives.

### Indirect drives - selection of motors

By far the most common drive is the squirrel cage induction motor, which is economical, reliable and produced worldwide.

The practice in sizing pump motors is to have a minimum safety factor, above the calculated absorbed power of 15 %.

This margin allows for uncertainties in the duty calculations and may allow duty modifications at a later date.

With V-belt drives, it is normal to selection four pole motors, as this provides the most economical drive arrangement. For turn down ratios exceeding 3:1 it may be necessary to use a 6 or even 8 pole motor.

## Drive arrangements

There are several drive arrangements available for electric motors with belt drives, i.e. overhead, reverse overhead, and side mounted.

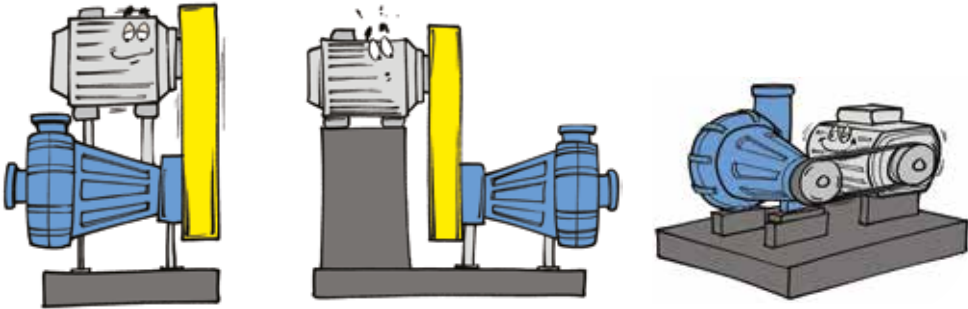

## Comments on drive arrangements

The most common drive arrangements are the side and overhead mounted motors. Overhead mounting is generally the most economical and lifts the motor off the floor away from spillage.

If the pump is of back pull out design or assembled on a sliding maintenance base, servicing can be significantly simplified.

Reverse overhead is a good compromise between maintainability and footprint and is common for larger pumps.

### Overhead mounting - limitations

The size of the motor is limited by the size of the pump frame, although a special straddle base may be available but it can restrict access to the frame.

If overhead mounting cannot be used, use side mounted motors (with slide rails for belt tensioning).

### V-belt transmissions (fixed speed drives)

Slurry pump impeller diameters (hard metal or elastomers) cannot easily be altered. For changes in performance, a speed change is necessary. With a V-belt drive, the pump can be fine tuned by changing one or both pulleys to achieve the duty point or when conditions are changed.

Provided the belts are installed correctly, modern V- belt drives are extremely reliable with a life expectancy of 40,000 hours and a power loss of 2–5 %.



### V-belt transmissions – limitations

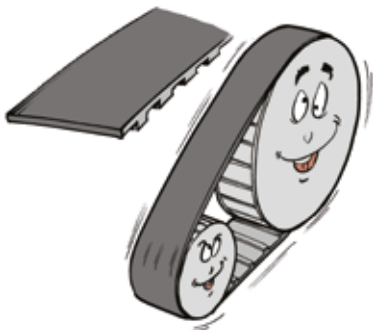

When pump speed is too low (dredge pumping) or when the power is too high, V-belts are not suitable.

In these cases gearboxes or toothed (synchronous) belts must be used.

Toothed (synchronous) belt drives are becoming more and more popular, giving the dynamic flexibility of a V-belt drive in combination with lower belt tension.



## Variable speed drives

For certain applications (varying flow conditions, long pipe lines, etc.) variable speed drives should be used.

With variable speed drives, the flow of a centrifugal pump can be closely controlled by tying the speed to a flow meter. Changes in concentration or particle size then have a minimal effect on flow rate.

Should a pipe line start to block, the speed will increase to keep flow velocity constant and help prevent blockage.

Modern electronic drives, particularly variable frequency drives (VFD), have many advantages and are widely used. However, be aware that motors need to be compatible for a VFD controlled system. Also, the drive system must be capable of meeting any changes in power requirements.

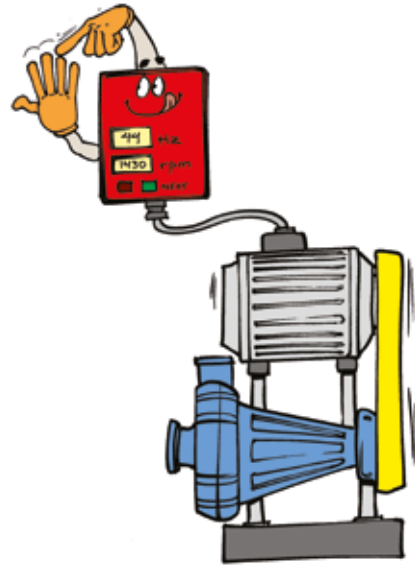

## Variable speed drives – limitations

Price can be a factor but continue to drop as market demands increase. At low speeds the motor fan may not be able to move sufficient air to cool the motor. In this case a separate, smaller motor is used to drive the fan. The waveform generated by the variable frequency drive can result in eddy currents inside the motor. If these are allowed to earth through the bearing then they can cause damage. Consult your motor vendor to understand how this can be avoided.

## Comments on combustion engine drives

In remote areas, or green field construction sites, temporary or emergency pumping equipment is often powered by industrial diesel engines. A ready to run assembled pump set, mounted on a portable base, provides variable performance in relation to variable engine speed. It is important to understand the speed range that they diesel engine can operate between on continuously duty (often 1500-1800 rpm).

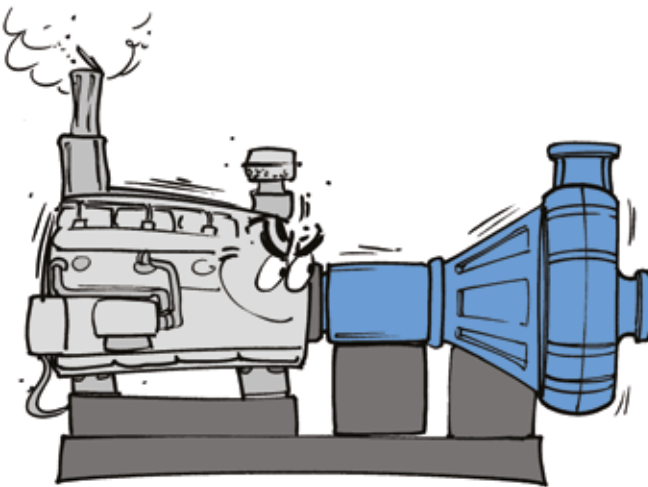

# 10. Hydraulic performance

To really understand a slurry pump and its system, it is essential to have a basic understanding of the performance of a slurry pump and how it works together with the piping system of the installation.

The optimal performance of a slurry pump application depends on two equally important hydraulic considerations:

1. The hydraulic conditions within the slurry pump and the system it is feeding covering:
  - Performance of the pump (outlet head and capacity)
  - Discharge piping and slurry system (friction losses)
  - Slurry effects on pump performance

2. The hydraulic conditions on the inlet side of the pump covering:
  - Slurry inlet head or lift - positive or negative
  - Barometric pressure (depending on altitude and climate)
  - Inlet piping (friction losses)
  - Slurry temperature (affecting vapour pressure of slurry)

**Note:** For optimal operation, these two hydraulic conditions must be considered and are equally important.

## Pump curves

The performance curves of a slurry pump are normally illustrated using data obtained from tests on clear water.

The basic curve for performance is the Head / Capacity (H/Q) curve, showing the relation between the discharge head of the slurry and the capacity (volume flow) at constant impeller speed.

## Types of H/Q pump curves

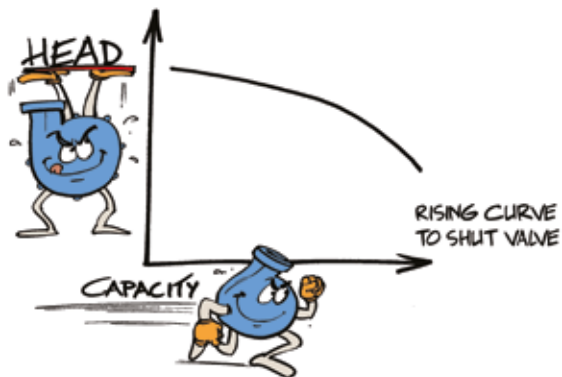

## Comments:

Sometimes specified (stable)

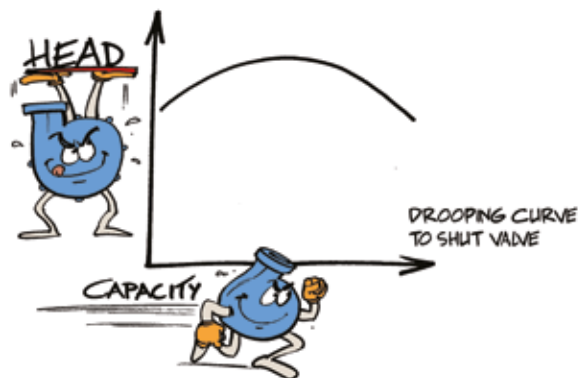

Sometimes unacceptable (unstable)

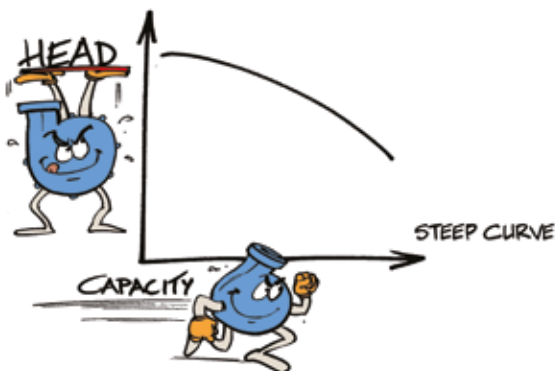

Sometimes desirable

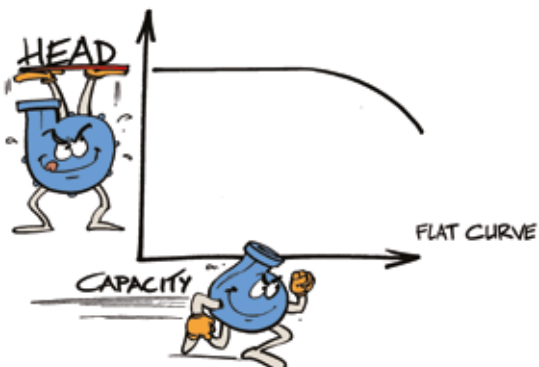

Most slurry pumps

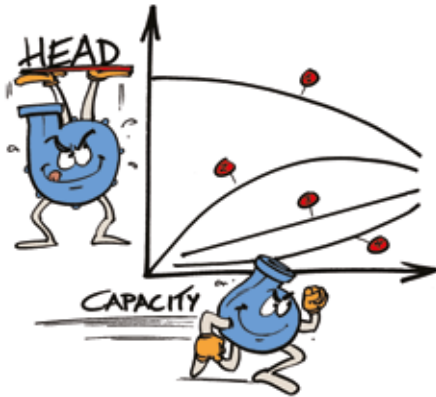

For a complete description of the performance of a slurry pump we need the following curves:

1. Differential head of the pump as function of the flow (HQ curve)
2. Efficiency curve as function of the flow
3. Power (input) as function of the flow
4. Cavitation characteristics as function of the flow (NPSHR)

### Hydraulic performance – what curves are needed?

**Note:** All the curves for head, power and efficiency are valid only if the head on the pump inlet is sufficient. If this is not the case, the pump performance will be reduced or will fail, read about Net Positive Suction Head (NPSH) on page 40.

### H/Q curves- pump affinity laws

To be able to describe the performance of a slurry pump at various impeller speeds or impeller diameters, we need to draw a range of curves. This is done by using the pump affinity laws.

### Laws for fixed impeller diameter

Parameter	Original condition	New condition
Speed	$N_1$	$N_2$
Head	$H_1$	$H_2$
Flow	$Q_1$	$Q_2$
Power	$P_1$	$P_2$

For a change in speed with a fixed impeller diameter, the new conditions can be calculated using the following equations:

$$Q_1/Q_2 = N_1/N_2 \quad \text{or} \quad Q_2 = Q_1 \times N_2/N_1$$

$$H_1/H_2 = (N_1/N_2)^2 \quad \text{or} \quad H_2 = H_1 \times (N_2/N_1)^2$$

$$P_1/P_2 = (N_1/N_2)^3 \quad \text{or} \quad P_2 = P_1 \times (N_2/N_1)^3$$

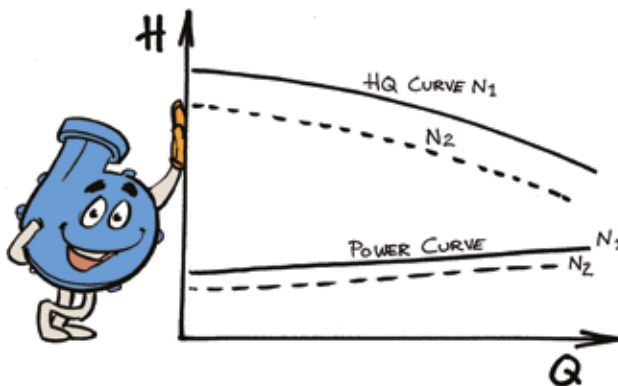

Efficiency remains approximately the same for small changes in speed.

### Laws for fixed impeller speed

Parameter	Original condition	New condition
Diameter	D <sub>1</sub>	D <sub>2</sub>
Head	H <sub>1</sub>	H <sub>2</sub>
Flow	Q <sub>1</sub>	Q <sub>2</sub>
Power	P <sub>1</sub>	P <sub>2</sub>

For a change in impeller diameter at constant speed, the new conditions can be calculated using the following equations:

$$Q_1/Q_2 = D_1/D_2 \quad \text{or} \quad Q_2 = Q_1 \times D_2/D_1$$

$$H_1/H_2 = (D_1/D_2)^2 \quad \text{or} \quad H_2 = H_1 \times (D_2/D_1)^2$$

$$P_1/P_2 = (D_1/D_2)^3 \quad \text{or} \quad P_2 = P_1 \times (D_2/D_1)^3$$

### Slurry effects on pump performance

As mentioned before, pump performance curves are based on clear water tests. Therefore corrections are needed when pumping slurries.

A given slurry must be treated as either settling or non-settling (viscous). Generally slurries with particle size <50 μm (0.002") are treated as non-settling (viscous).

### Pump performance with settling slurries

For settling slurries, pump performance is affected by particle size, shape, specific gravity, concentration, and type of distribution in the slurry mixture. As a result, it becomes necessary to apply head and efficiency (HR and ER) derating factors to the water curves to correctly size the pump.

Metso Outotec's proprietary PumpDim™ sizing program has been developed to account for slurry properties including pump size (impeller diameter) effects. The option of using the Hydraulic Institute's pump sizing method is also available. Several techniques are available in the slurry pumping industry for calculating derating factors.

An example below being of a graph from the Hydraulic Institute Standard "12.1-12.6: Rotodynamic (Centrifugal) Slurry Pumps for Nomenclature, Definitions, Applications and Operation"

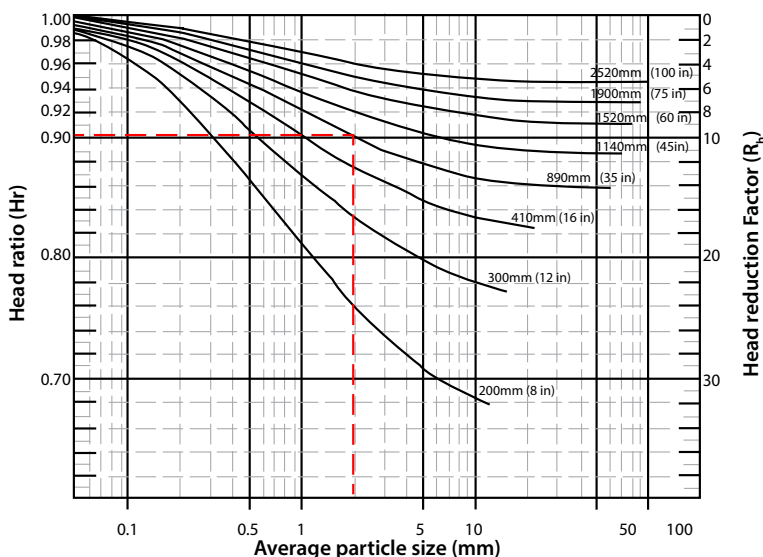
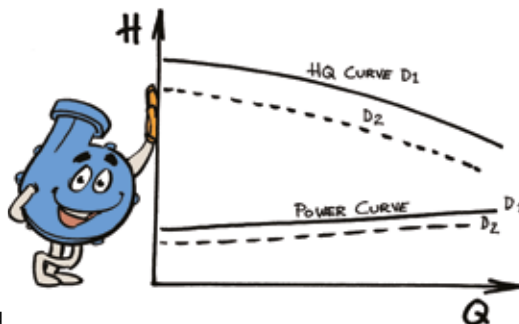

Information from HI Standards reproduced courtesy of Hydraulic Institute, Parsippany, NJ [www.Pumps.org](http://www.Pumps.org)

The curves are based for a solids concentration by volume,  $C_v = 15\%$ , solids specific gravity (SS) = 2.65 and negligible amount of fine particles. Impeller diameters are given in mm (inches).

Knowing the average particle size ( $d_{50}$ ) and the pump impeller diameter, it is possible to determine the Head Correction factor ( $H_R$ ). Typically,  $H_R = E_R$ .

- Slurry head = Water curve head x  $H_R$
- Slurry efficiency = Water efficiency x  $E_R$

Water head and slurry flow rate are used to determine pump speed and water efficiency. Slurry head and slurry efficiency are used to calculate power. For slurry properties other than those given above, additional correction factors for Specific Gravity ( $C_s$ ), Fine-particles ( $C_{fp}$ ) and Concentration ( $C_{cv}$ ) apply to  $H_R$  and  $E_R$ .

Reference should be made to the Hydraulic Institute Standard for detailed calculations when using this method.

### Pump performance with non-settling (viscous) slurries

The viscosity of a fluid can affect the performance of a pump. Since pump curves are based on water tests, it may be necessary to derate the unit to meet duty conditions. Fluids may have Newtonian or Non-Newtonian viscous characteristics and this too affects the pumps sizing process (see Chapter 11 for viscosity discussion).

For viscous liquids exhibiting Newtonian behavior, pump performance is derated per the guidelines given in Hydraulics Institute standard ANSI/HI 9.6.7: "Effects of Liquid Viscosity on Rotodynamic (Centrifugal and Vertical) Pump Performance".

Non-settling slurries typically exhibit non-Newtonian behavior and Metso Outotec's proprietary PumpDim™ sizing program has been developed to select pumps for this type of fluid.

Contact Metso Outotec Proposal Support when working with nonsettling slurries.

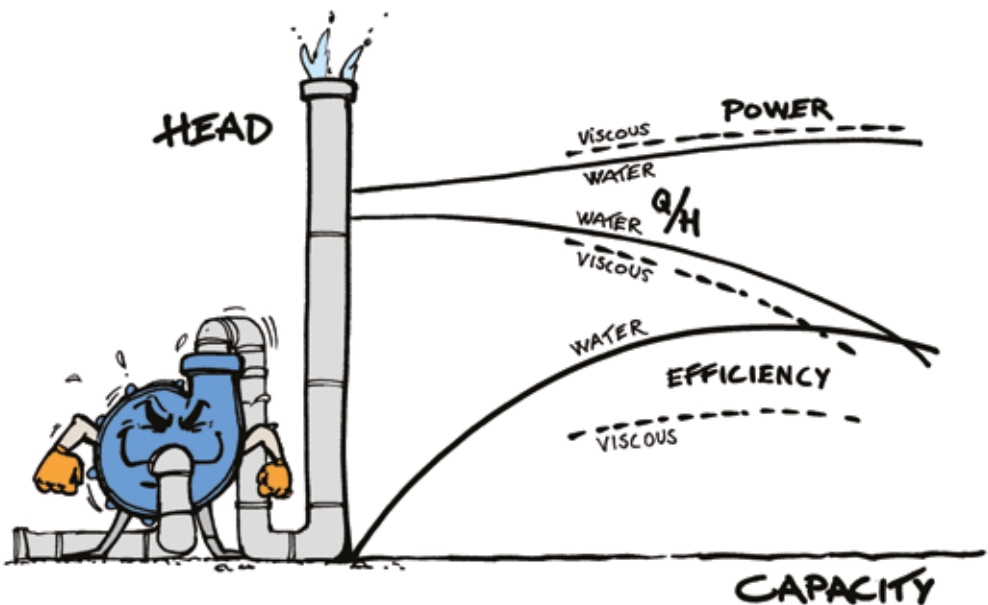

## Head and pressure

It is important to understand the difference between head and pressure when it comes to performance of a slurry pump.

Centrifugal pumps generate head not pressure.

The relationship between head and pressure is given as:

Head (H) meters	Pressure (P) in 'bar' = $\frac{(H \times \text{specific gravity})}{(10.2)}$
Head (H) feet	Pressure (P) in 'psi' = $\frac{(H \times \text{specific gravity})}{(2.31)}$

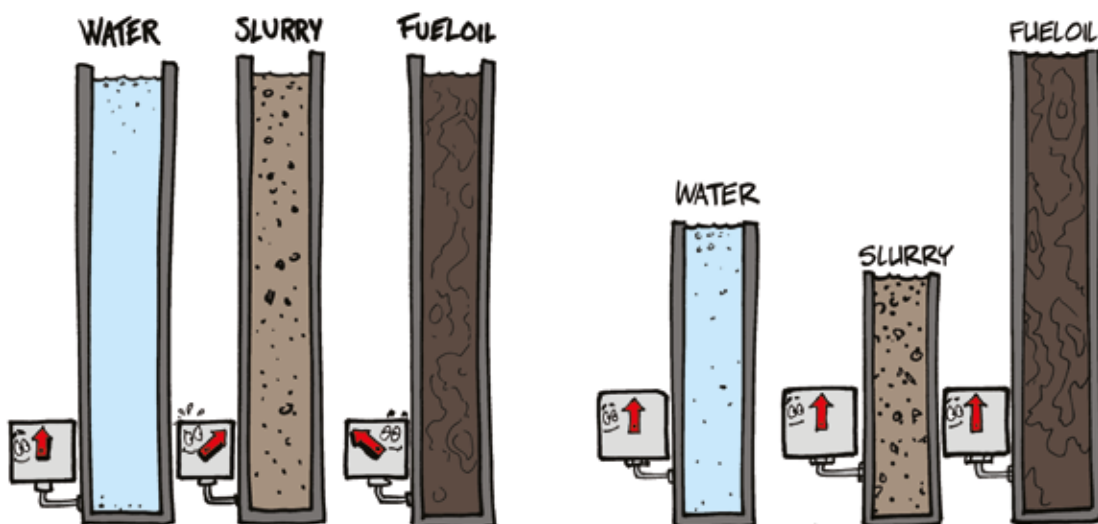

### Example

For a pump producing 51.0 m (167 ft) of head of water, the gauge pressure would be 5.0 bar (72.5 psi).

On a heavy slurry of S.G 1.5, the 51.0 m (167 ft) would show a gauge reading of 7.5 bar (108.8 psi).

On a light fuel oil duty of S.G 0,75, the 51.0 m (167 ft) would show a gauge reading of 3.75 bar (54.4 psi).

**Note:** For the same head, gauge reading and required pump power will vary with specific gravity (SG).

### Problem with measuring head with a gauge

Even if the gauge is marked to show meters it really measures pressure.



## Hydraulic conditions on the inlet side

### Net Positive Suction Head (NPSH)\*

To ensure that a slurry pump performs efficiently, the liquid must be above the vapor pressure inside the pump.

This is achieved by having sufficient pressure, referred to as  $NPSH_A$  (Net Positive Suction Head Available), on the suction (inlet) side of the pump.

If this pressure is too low, then the pressure at the impeller inlet would decrease to the lowest possible pressure of the pumped liquid, the vapor pressure.

**Note:** Net Positive Head is always expressed in absolute pressure units.

Cavitation is mainly an issue when:

- The site is at high altitude
- Operating on a suction lift  
See also page 43
- Pumping liquids under conditions near their vapor pressure limits



### Vapor pressure and cavitation

When the local pressure drops to the liquid vapor pressure, vapor bubbles start to form. These bubbles are carried by the liquid to locations with higher pressure, where they collapse (implode) creating extremely high local pressures (up to 10000 bar) (145000 psi), which can erode the pump surfaces. These mini explosions are called cavitation, see also page 43.

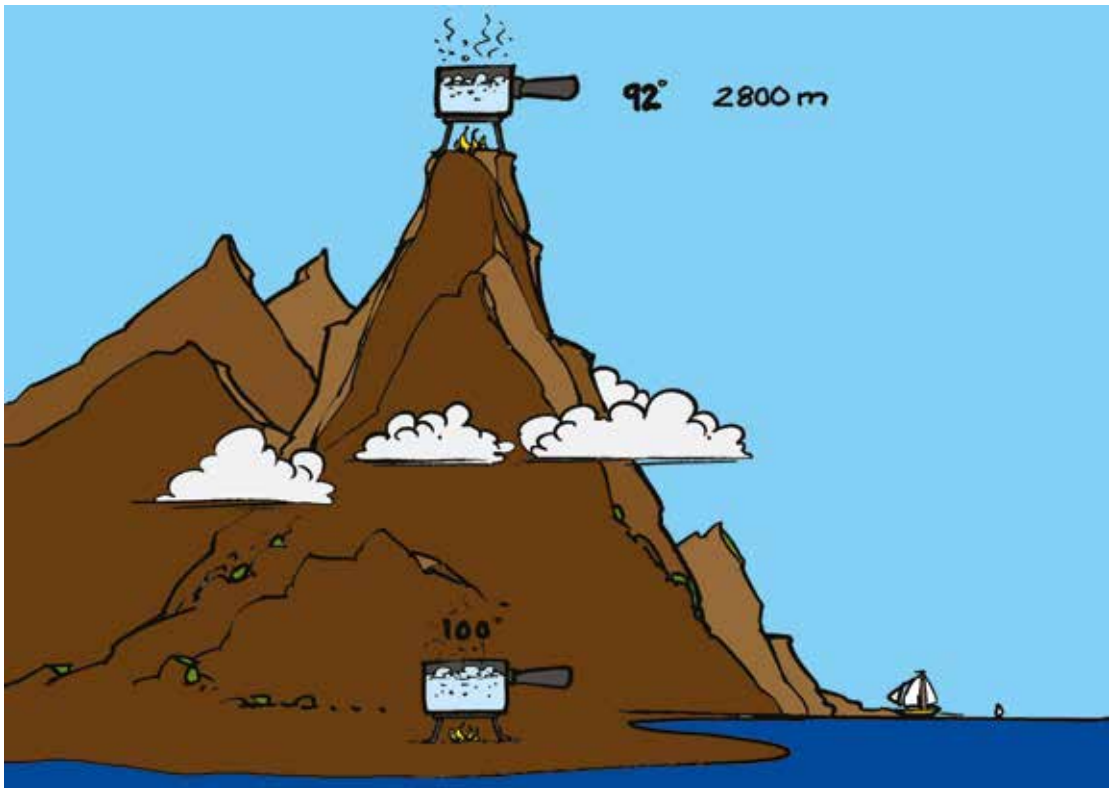

*\*The term NPSH is an international nomenclature standard and is used in most languages.*

Cavitation is not, as sometimes stated, generated by air in the liquid. It is the liquid boiling at a certain temperature as the ambient pressure reduces to the Vapor Pressure of the liquid.

By definition, at sea level, the Standard Atmospheric Pressure (atm) is 1.013 bar (14.7 psi) and water boils at 100 °C (212 °F). At an altitude of 2800 m (9186 ft), atmospheric pressure reduces to 0.72 bar (10.4 psi) and water boils at 92 °C (198 °F). See page 42.

A major effect of cavitation is a marked drop in pump performance, caused by a drop-off in capacity and head. Vibrations and mechanical damage can also occur.

**Too low  $NPSH_A$  will cause cavitation**

**How to calculate  $NPSH$ ?**

How do we know what  $NPSH_A$  (inlet head) we are looking for? For all pumps there is always a required value for the  $NPSH$  known as  $NPSH_R$ . This is not a calculated value, it is a property of the pump and determined during performance testing. Pump curves typically show  $NPSH_R$  for varying flows and speeds.

The hydraulic conditions at the inlet side of a given system must provide the  $NPSH_A$ . Therefore, it is important to check the  $NPSH_A$  during the sizing.

For the installations above, a check for  $NPSH_A$  on the suction side is necessary.

**Note:**  $NPSH_A$  must always be greater than  $NPSH_R$

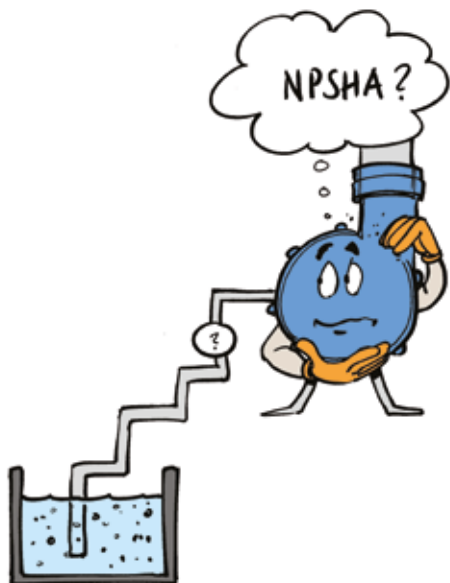

*Negative inlet static head (suction lift)*



*Positive inlet static head*

### NPSH - calculations

We have to summarise all heads and deduct all losses in the piping system on the inlet side.

Atmospheric pressure changes with altitude and can be expressed in terms of water head as listed in the table or read from the graph.

Altitude		H <sub>2</sub> O Head	
meters	feet	meters	feet
0	0	10.3	33.9
1000	3281	9.2	30.1
2000	6562	8.1	26.6
3000	9843	7.2	23.5

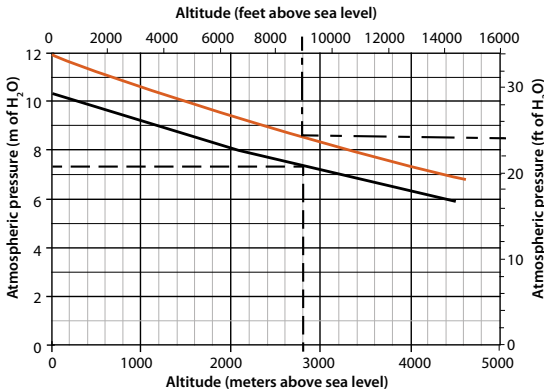

Curve showing atmospheric pressure versus altitude.

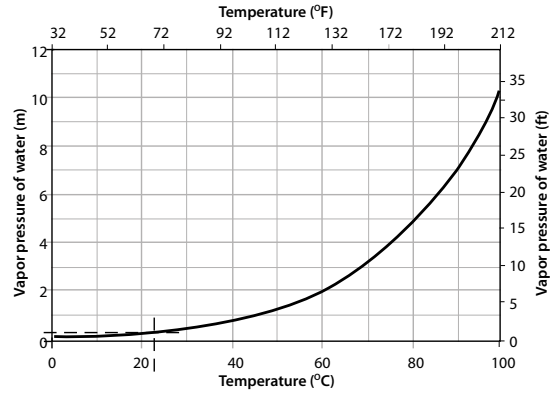

Curve showing vapor pressure for water at different temperatures.

### Formula for calculating NPSH<sub>A</sub>

$$\text{NPSHA} = \text{Atmosphere pressure} + (-) \text{static Head} - \text{system losses} - \text{vapor pressure}$$

**Note:** Atmospheric pressure should be in meters or feet of liquid column.

### Example:

A light slurry,  $sg = 1$ , application using a Metso Outotec HM150 slurry pump installed at high altitude, e.g. Chuquicamata, Chile.

	Metric	Imperial
Site elevation above sea level	2800 m	9186 ft
Atmospheric pressure (see graph)	7.3 m	24 ft
Duty: Flow rate	325 m <sup>3</sup> /hour	1431 US gpm
Total Dynamic Head (TDH)	50 m	164.0 ft
Operating temperature	22 °C	72 °F
Vapor pressure (see graph)	0.3 m	1 ft
Static head – suction lift	2.0 m below pump inlet	6.6 ft
Calculated inlet friction losses	0.5 m	1.6 ft
NPSH <sub>R</sub> from pump curves	6.3 m	20.7 ft
Calculated NPSH <sub>A</sub> (see equation)	$[7.3-2-0.5-0.3] = 4.5 \text{ m}$	$[24-6.6-1.6-1] = 14.8 \text{ ft}$
NPSH <sub>A</sub> - NPSH <sub>R</sub> = -1.8 m (-5.9 ft). Therefore, NPSH <sub>A</sub> is too low.		

For the same duty conditions at an installation in Northern Europe at sea level, the atmospheric pressure would be 10.3 m (33.9 ft).

Calculated NPSH <sub>A</sub> (see equation)	$[10.3-2-0.5-0.3] = 7.5 \text{ m}$	$[33.9-6.6-1.6-1] = 24.7 \text{ ft}$
NPSH <sub>A</sub> - NPSH <sub>R</sub> = 1.2 m (4.0 ft). Therefore, NPSH <sub>A</sub> is OK.		

## Cavitation — a summary

If  $NPSH_A$  is less than  $NPSH_R$ , liquid will vaporise in the eye of an impeller. If the cavitation increases, the amounts of vapour bubbles will severely restrict the available cross sectional flow area and it can actually vapour lock the pump, thus preventing liquid from passing through the impeller.

When the vapour bubbles move through the impeller to a higher pressure region, they collapse with such force that mechanical damage can occur.

Mild cavitation may produce a little more than a reduction in efficiency and moderate wear. Severe cavitation will result in excessive noise, vibration and damage.

**Note:** Compared to process pumps, slurry pumps suffer less damage by cavitation due to their heavy design, wide hydraulic passages, and material used.

## Pumps operating on suction lift

When calculating pump duties at a high altitude on page 42, it was shown that the suction condition was critical to pump performance.

Normally, the standard slurry pump will operate satisfactorily on suction lift applications, however only within the limits of the pump design, meaning " $NPSH_A$  must always be greater than  $NPSH_R$ ."

Maximum suction lift is easily calculated for each application, using the following formula.

Max. possible suction lift = atmospheric pressure -  $NPSHR$  - system losses - vapor pressure.

**Note:** A pump must be primed for satisfactory operation.

## Priming of slurry pumps

For any centrifugal pump, we need to replace the air in the pump with liquid.

This can be done manually, but usually these applications occur in industrial environments, where we need an automatic device.

## Automatic priming

One way of automatic priming is to use a vacuum assisted self priming system. It is important to note that automatic self priming equipment does not increase the NPSH available.

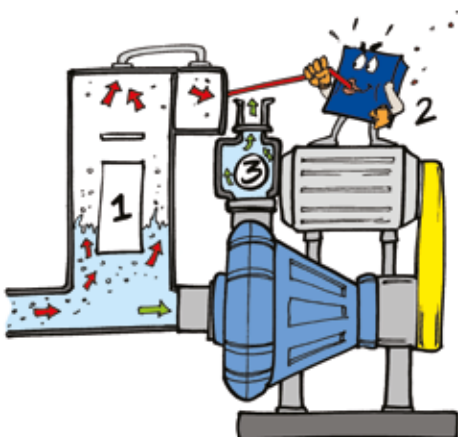
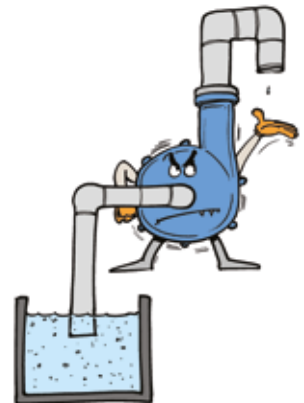

The system requires these basic components added to the slurry pump:

1. Priming tank, bolted to the pump suction side, regulating the water level and protecting the vacuum pump from the ingress of liquid
2. Vacuum pump continuously driven from the main pump shaft, evacuating air from the pump casing
3. Discharge, non return valve, fitted to the pump outlet, isolating the outlet line during priming conditions

## Froth pumping

Pumping of froth (from flotation or other processes) is a classical problem area of slurry pumping.

In a horizontal pump system, the problem occurs when frothy slurry gets into contact with the rotating impeller. In this situation, the froth starts to rotate in the pump inlet.

The centrifugal force creates a separation of liquid and air, throwing the liquid outwards and the air collects at the center. The trapped air blocks the path of slurry into the pump and the hydraulic performance of the pump is reduced.

The liquid level in the sump now starts to rise, the inlet pressure increases, compressing the trapped air until the slurry reaches the impeller vanes again. Now pumping starts again and the trapped air is swept away.

However then a new air lock will start to build up and the change in performance is repeated, and will continue to be repeated. The result is a fluctuating performance.

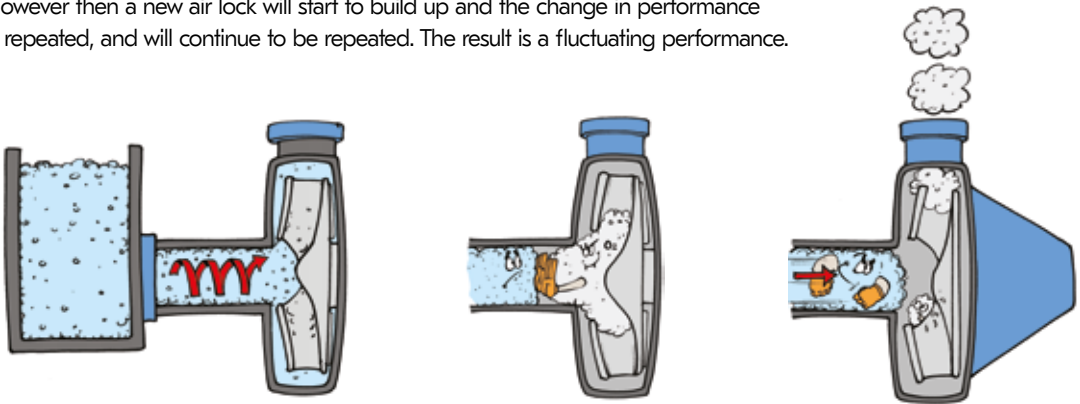

## Froth sizing of horizontal pumps

If horizontal slurry pumps are the only option, the following rules should be followed to get improved hydraulic performance.

### Over-size the pump

- A large inlet allows more air to escape
- A wider pump inlet is harder to obstruct

### Sump height must be increased

- To be effective the sump must have a height of 6 - 10 m (20 - 33')

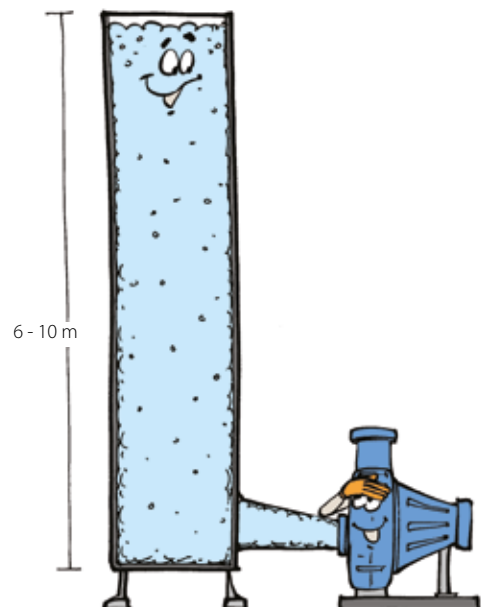

## Vertical slurry pumps – the optimal choice for froth pumping

The vertical slurry pumps were originally developed for fluctuating slurry flows and **froth pumping**. Metso Outotec's three vertical slurry pumps, models VT, VS and VF, can be used for froth pumping.

**The VT tank pump** consists of a pump and a pump tank integrated into one unit. The pump casing is located under the tank, and connected to the tank through a hole in the bottom of the tank.

The air, concentrated at the center of the impeller, is simply released upwards along the shaft.

**The VS sump pump** has the feed entrance from the bottom of the casing. The impeller has operating vanes on the lower side and small sealing vanes on the top side.

The basic design of the VS pump casing has two spray holes through which the casing is constantly de-aerated.



VT tank pump

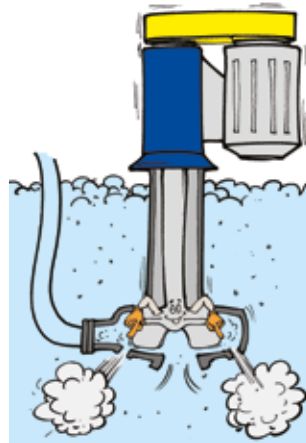

VS sump pump

**The VF froth pump** is specifically designed for froth pumping.

### Design criteria

- The pump shaft is located in the center of the tank
- The tank is conical and covered
- The tank has a tangential feed inlet

### Function

The tangential feed imparts a strong vortex action in the conical tank, similar to the function of a hydrocyclone. The shear and centrifugal forces in this vortex break up (or destroy) the binding between the air bubbles and the solids thus separating air from the slurry.

The free air is released upwards along the center shaft giving blockage free performance. The covered tank with its patented vortex finder increases performance and reduces spillage.

### Advantages

Increased capacity through the pump system. Integrated tank.

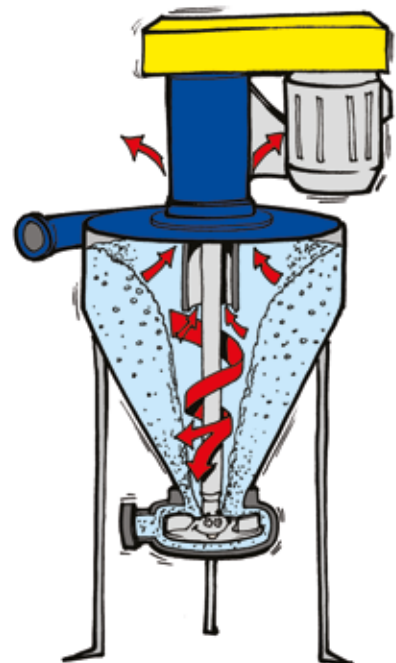

VF froth pump

# 11. Slurry pump systems

## General

Having looked at the suction (inlet) side of the slurry pump, we must now look closely at the outlet side, where we have to consider the hydraulic losses in the slurry system.

Installed in a piping system, a slurry pump must be rated against the static head, any delivery pressure, and all friction losses to be able to provide the required flow rate.

The duty point will be where the pump performance curve crosses the system head curve.

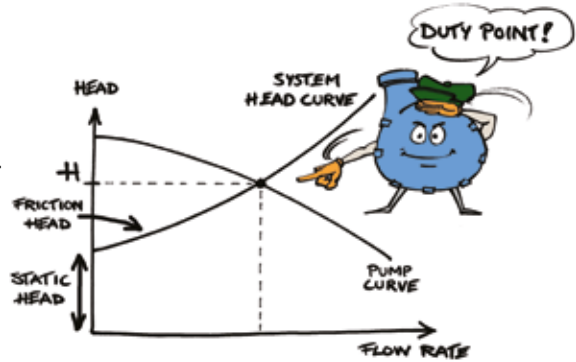

Never over estimate the system resistance. If over estimated, the slurry pump will:

- Give a greater flow than required
- Absorb more power than expected
- Run the risk of overloading the motor (and in worst cases suffer damage)
- Cavitate on poor suction conditions
- Suffer from a higher wear rate than expected
- Suffer gland problems

**Note:** Always use the best estimate of system head. Add safety margins to the calculated power only.

## Basic on pipe systems

### The pipe system

The total head in a liquid is the sum of the static head (potential energy), pressure head (pressure energy), and velocity head (kinetic energy). In simple terms, this can be expressed by Bernoulli's Equation for conservation of energy:

$$\text{Total Head} = H + P + V^2 / 2g$$

The head (energy) the pump has to supply to the liquid to gain the required flow rate is the difference between the total head at the outlet flange and the total head at the inlet.

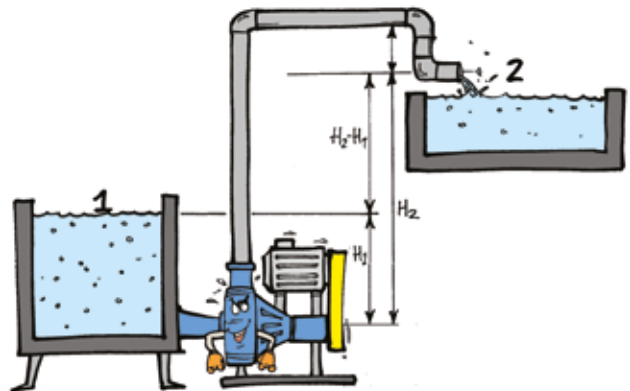

As we do not know the conditions at the pump flanges, we must select a known condition on each side of the pump and then allow for pipe work losses between these points and the flanges to determine the total head at the flanges.

In the diagram above, the total head is known at the liquid surface in the feed tank (Point 1) and the outlet pipe exit (Point 2).



<b>At point 1</b>	Static head	= $H_1$
	Pressure head	= 0 (atmospheric pressure)
	Velocity head	= 0 (practically no velocity)
<b>therefore</b>	Pump inlet head	= $H_1$ – inlet pipe losses
<b>At point 2</b>	Static head	= $H_2$
	Pressure head	= 0 (atmospheric pressure)
	Velocity head	= $V_2^2 / 2g$
	Where $V_2$	= Flow velocity at point 2 in m/s
	$g$	= Gravitational constant = 9.81 m/s <sup>2</sup>
<b>therefore</b>	Pump outlet head	= $H_2 + V_2^2 / 2g$ + outlet pipe losses
	Pump differential head (PDH)	= Outlet head – inlet head
	PDH	= ( $H_2 + V_2^2 / 2g$ + outlet pipe losses) – ( $H_1$ – Inlet pipe losses)

In practice, velocity head is typically a small value and, for easy calculating, is ignored. For example, 3.0 m/s (9.8 ft/s) gives a velocity head of 0.46 m (1.5 ft).

**then** PDH =  $H_2 - H_1 +$  outlet losses + inlet losses

**Note:** PDH (Pump Differential Head) is also known as the Total Dynamic Head (TDH)

## Friction losses

### Straight pipes

Similar to a voltage drop in a power cable, there are friction losses in a pipe system. If Metso Outotec's PumpDim™ is not available then, as an approximate calculation, the diagram on the next page can be used.

Friction loss in a straight pipe varies with:

- Diameter
- Length
- Material (roughness)
- Flow rate (velocity)

The friction loss can either be:

- Looked up in a table
- Extracted from a Moody diagram
- Calculated from semi-empirical formula, such as the Hazen & William equation
- Calculated using software such as Metso Outotec's Pump™ program

### Fittings

When a system includes valves and fittings, an allowance for additional friction is needed. The most common method for calculation of friction loss caused by fittings is called the Equivalent pipe length method. This method can be used for liquids other than water, i.e. viscous and non-Newtonian flows. The fitting is treated as a length of straight pipe giving equivalent resistance to flow. See table on page 49.



## TEL – Total Equivalent Length

TEL = Straight pipe length + equivalent length of all pipe fittings.

### Velocities and friction losses for clear water in smooth steel pipes – Calculation chart

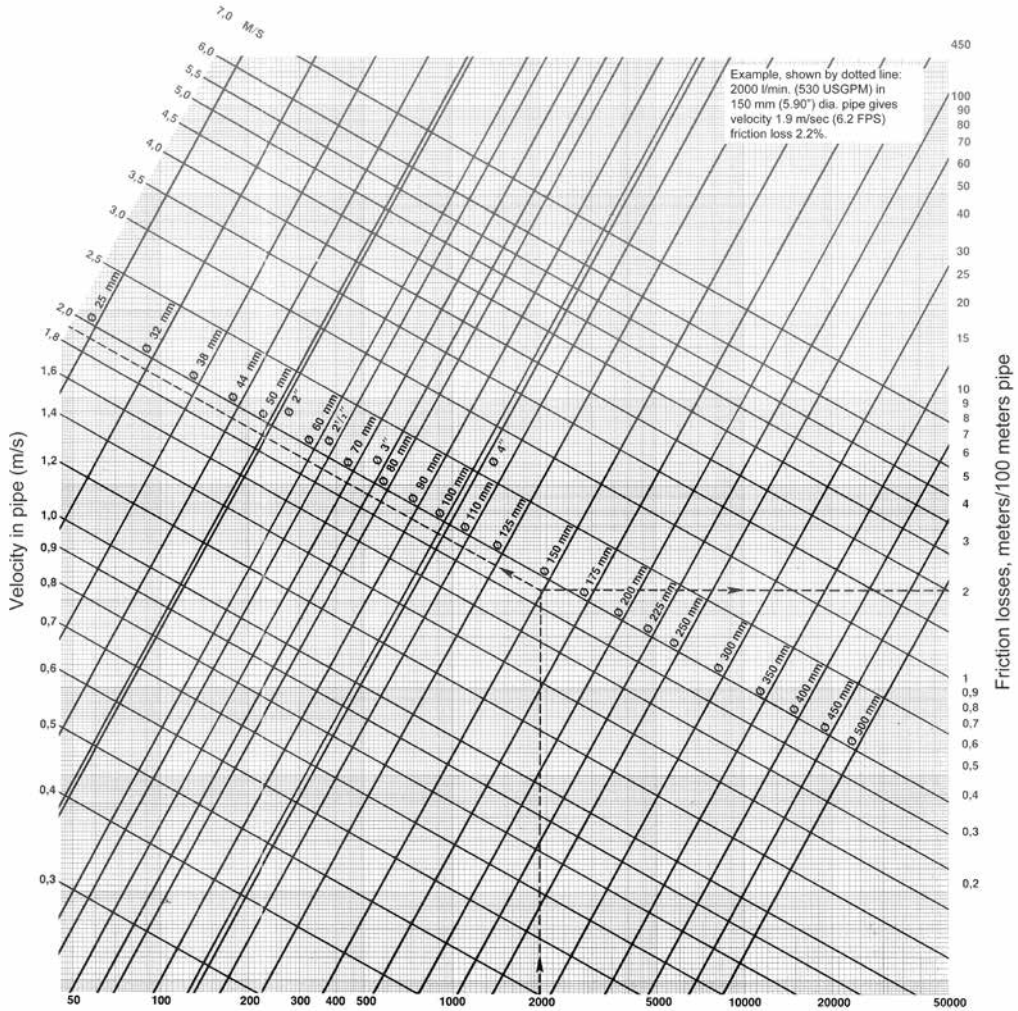

### Pumping of slurries

When calculating the pipe friction losses for a slurry (suspension of solid particles in water), it is advisable to allow for a certain increase when compared with the losses for clean water. Concentrations up to around 15 percent by volume may be assumed to behave as water. For higher concentrations, friction losses should be corrected by a factor taken from the diagram on the right.

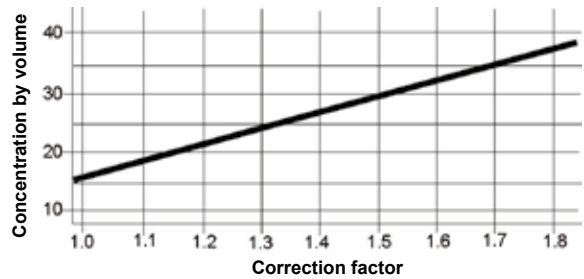

Calculated values must be used for rough estimates only

## Valves, fittings, head losses

Approx. resistance of valves and fittings frequently used on slurry pipelines.



Pipe Size N.B (mm)	R>3xN.B. Long radius bend	R=2xN.B. Short radius bend	Elbow	Tee	R>10xN.B. Rubber hose	Dia-phr. Full open	Full Bore valve	Plug Lub Valve rect way
25	0.52	0.70	0.82	1.77	0.30	2.60	-	0.37
32	0.73	0.91	1.13	2.40	0.40	3.30	-	0.49
38	0.85	1.09	1.31	2.70	0.49	3.50	1.19	0.58
50	1.07	1.40	1.67	3.40	0.55	3.70	1.43	0.73
63	1.28	1.65	1.98	4.30	0.70	4.60	1.52	0.85
75	1.55	2.10	2.50	5.20	0.85	4.90	1.92	1.03
88	1.83	2.40	2.90	5.80	1.01	-	-	1.22
100	2.10	2.80	3.40	6.70	1.16	7.60	2.20	1.40
113	2.40	3.10	3.70	7.30	1.28	-	-	1.58
125	2.70	3.70	4.30	8.20	1.43	13.10	3.00	1.77
150	3.40	4.30	4.90	10.10	1.55	18.30	3.10	2.10
200	4.30	5.50	6.40	13.10	2.40	19.80	7.90	2.70
250	5.20	6.70	7.90	17.10	3.00	21.00	10.70	3.50
300	6.10	7.90	9.80	20.00	3.40	29.00	15.80	4.10
350	7.00	9.50	11.00	23.00	4.30	29.00	-	4.90
400	8.20	10.70	13.00	27.00	4.90	-	-	5.50
450	9.10	12.00	14.00	30.00	5.50	-	-	6.20
500	10.30	13.00	16.00	33.00	6.10	-	-	7.30

Length in meters of straight pipe giving equivalent resistance to flow.

Metric to inch conversion for use with above chart and table.

Measurement	Metric	Inch: multiply by
Length	1 mm	0.039 inch
	1 m	3.28 (ft)
Velocity	1 m/s	3.28 (ft/s)
Flow	1 l/min	0.264 (US gpm)

### Slurry effects on friction losses

As is the case for pump performance, friction losses are also affected by slurries since they behave differently than clear water. The slurry has to be treated either as settling or non-settling (viscous).

Generally, slurries with particle size <50 micron are treated as non-settling.

### Friction losses settling slurries

The assessment of friction losses for settling slurries is very involved, and best accomplished on computer software such as Metso Outotec's PumpDim™.

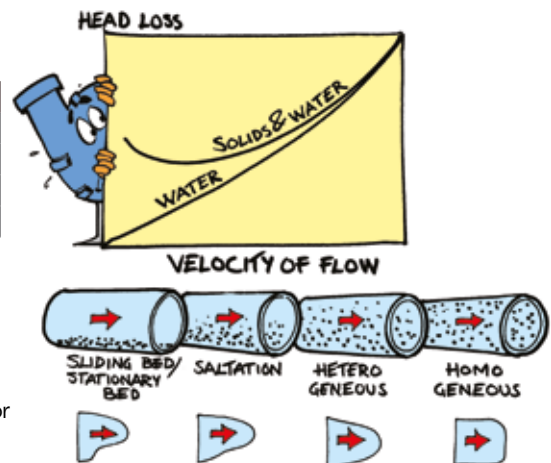

At low velocities, head loss is difficult to predict, and there is a real risk of solids settling out and blocking the pipe. The illustration below highlights the effect on friction loss versus flow velocities. Also shown are the various flow regimes that can occur in the pipeline at these carrying velocities.

However, for short runs of pipe at higher velocities, head loss can be taken as being equal to the water losses. For approximate estimations, the correction factor on the bottom of page 48 can be used.

The nomogram can be used to calculate a safe minimum velocity. Velocities are reliable slurries that consist of a single particle size or have a narrow particle size distribution profile. Nomographic chart for minimum velocity. (Adapted from Wilson, 1976)

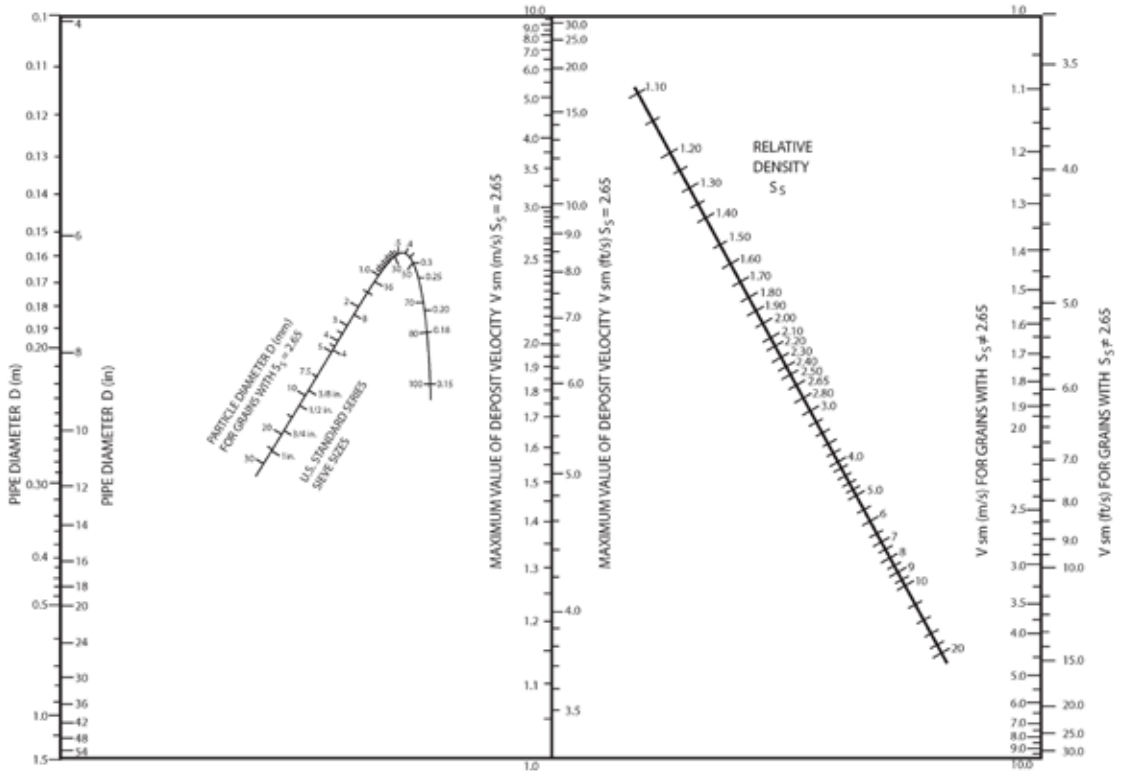

Nomographic chart for minimum velocity. (Adapted from Wilson, 1976).

Example: Pipe diameter = 0.250 m (9.84 inch)

Particle size = 0.5 mm (32 Mesh): [worst case]

Particle S. G. = 3.8

Minimum velocity = 4.5 m/s (14.8 ft/s)

Information from HI Standards reproduced courtesy of Hydraulic Institute, Parsippany, NJ [www.pumps.org](http://www.pumps.org)

Contact Metso Outotec Proposal Support when working with complex mixtures.

### Friction losses non-settling slurries

Friction loss assessments for non-settling slurries are best accomplished with the aid of computer software. However, there are numerous methods of manually making assessments, although these can prove difficult because of all the variables involved.

Whatever method is used, full rheology of the viscous solution is necessary for any accurate assessment.

Assumptions can prove to be very inaccurate.

## Summary

It is very important that all the losses in a slurry system are calculated in the best way possible, enabling the pump to balance the total system resistance, operate at the correct duty point, giving correct head, and capacity. Use Metso Outotec's PumpDim™ computer software.

## Sump arrangements

Below you will find some useful guidelines for the design of pump sumps for slurries:

### Horizontal pump sump

Separate sumps are preferred for standby pump installations. This will avoid settling out in the standby pump sump when not in use.

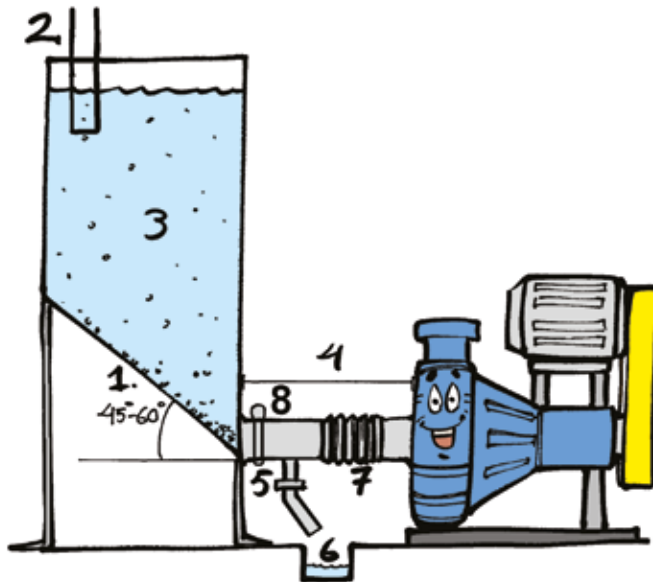

1. **Sump bottom** should have an angle of at least 45°. Fast settling particles may need up to 60°
2. **Sump feed** should be below the liquid surface to avoid air entrainment. This is especially important with frothy slurries
3. **Sump volume** should be as small as possible. Sizing parameter used is the retention time for slurry; down to 15 seconds for coarse particles, and up to 2 minutes for fine particles
4. **Sump connection** to the slurry pump should be as short as possible. As a basic rule it should be 5 x pipe diameter in length and never be less than the size of the pump inlet. Avoid lengths longer than 10 x pipe diameter
5. **Drain connection** on the inlet pipe. It's recommended to have a floor channel (6) under the drain to recover the slurry
7. **Flexible inlet connection** that is reinforced since a vacuum can be created
8. Full bore shut off valve

## Floor sumps

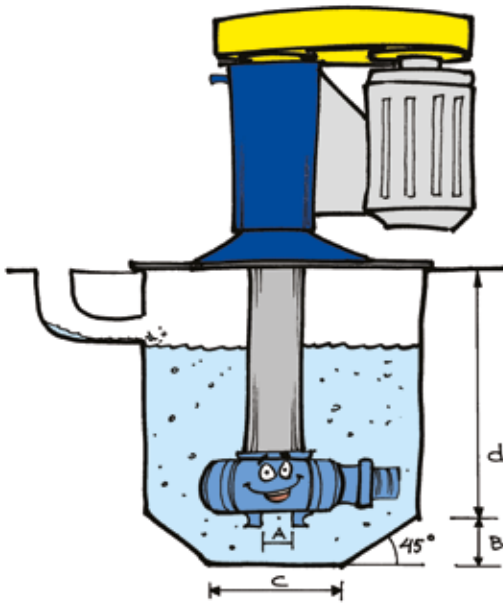

- **Sump volume** as small as possible (to avoid sedimentation)
- **Sump depth** from pump inlet (B) to be two times the pump inlet diameter (A). Allow for agitator length if one is used
- **Sump bottom** (flat section C) to be 4-5 times the pump inlet diameter (A). 45 degrees slope to sump walls
- **Sump depth** – (d) should be selected considering required retention time and the necessary standard pump lower frame length to suit this depth

## Multiple-pump installations

There are two cases when we need multiple installations of slurry pumps:

1. When the head is too high for a single pump
2. When the flow is too great for a single pump

### Pumps in series

When the required head is not achieved with a single pump, two (or more) pumps can be operated in series.

For two pumps in series, the discharge from the first stage pump is connected directly to the second pump, effectively doubling the head produced. For two identical pumps in series, the system will have the same efficiency as the individual pumps.

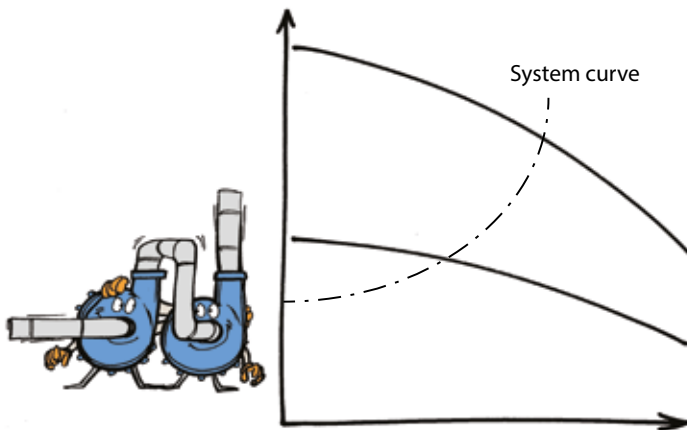

## Pumps in parallel

When the required flow is not achievable with a single pump, two (or more) pumps can be operated in parallel. For two pumps in parallel the discharge from both pumps is connected to the same line.

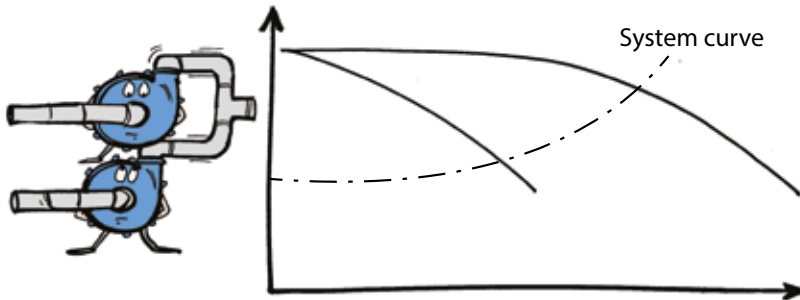

## Basics of viscosity

In slurry pumping we are sometimes coming across the word viscosity.

Put simply viscosity = the slurry's ability to flow

This ability to flow is dependent on the internal friction in the slurry, i.e. the capability to transfer shear stress (or movement) within the slurry.

Generally, there are two types of liquid when discussing this ability to flow: Newtonian and Non-Newtonian.

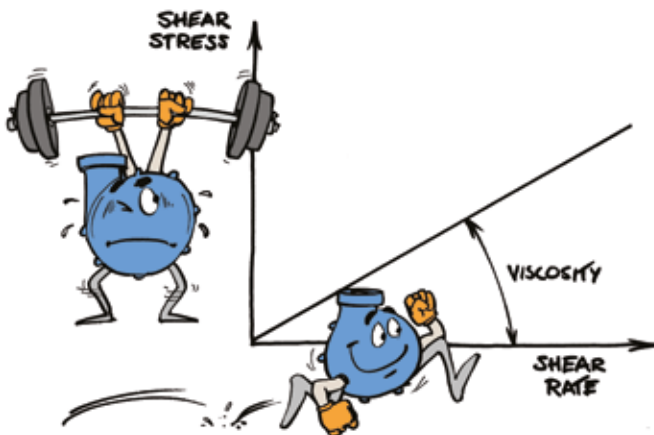

### Newtonian

A Newtonian liquid's movement or shear rate is linear and proportional to the input of kinetic energy which creates a shear stress in the slurry.

Viscosity is defined as the tangent of the angle and is constant for a Newtonian slurry. Typical Newtonian liquids are water and oil.



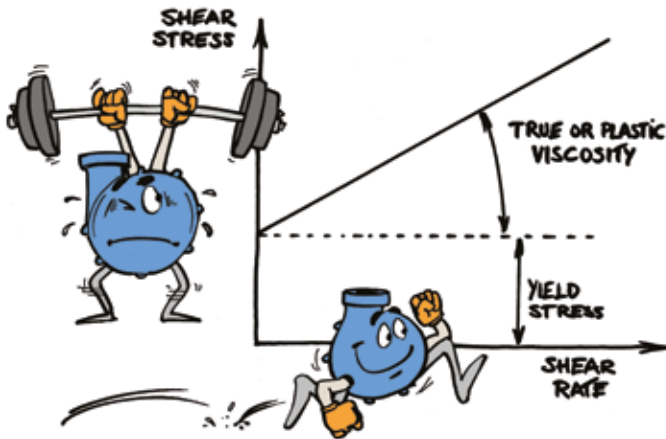

### Non-Newtonian

Most high concentration fine particle slurries are non-Newtonian and have what is known as plastic behavior.

This means that energy must be put into the slurry in order to start flow, e.g. a fine sediment in the bottom of a bucket needs to be helped by knocking the bottom to get it to flow out. When the energy level is reached the relation between liquid movement and energy is a straight line.

To establish friction losses - or effects on pump performance for plastic slurries the true plastic dynamic viscosity and the energy level (yield stress) for the flow point have to be verified.

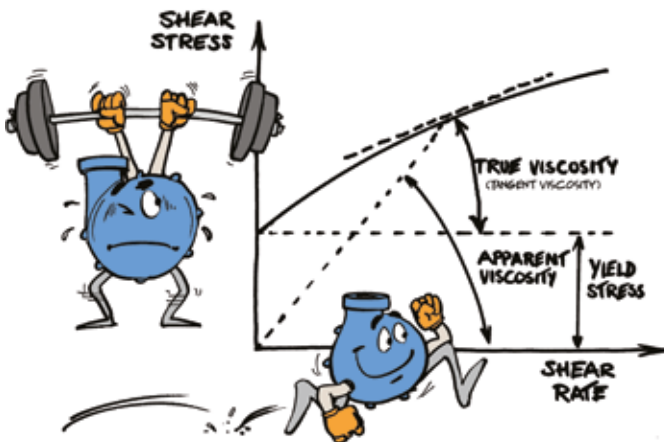

### Apparent viscosity

The apparent viscosity is often mistakenly assumed the same as the true or plastic dynamic viscosity.

The apparent viscosity changes with shear rate as shown in the diagram above. Typically testing should be done at shear rates between 10-1000 reciprocal seconds shear rate. Any data below this risks poor results due to solids settling in the apparatus.

### Other non-Newtonian fluids

There are other non-Newtonian fluids in which the shear stress is not linear with shear rate. Dilatant (shear thickening) fluids where viscosity increases with energy input, (e.g. organic polymers and paper pulp).

Pseudoplastic fluids (shear thinning) decrease in viscosity with energy input (e.g. paints, inks, mayonnaise). The graph below illustrates the behavior of Newtonian and non-Newtonian fluids.

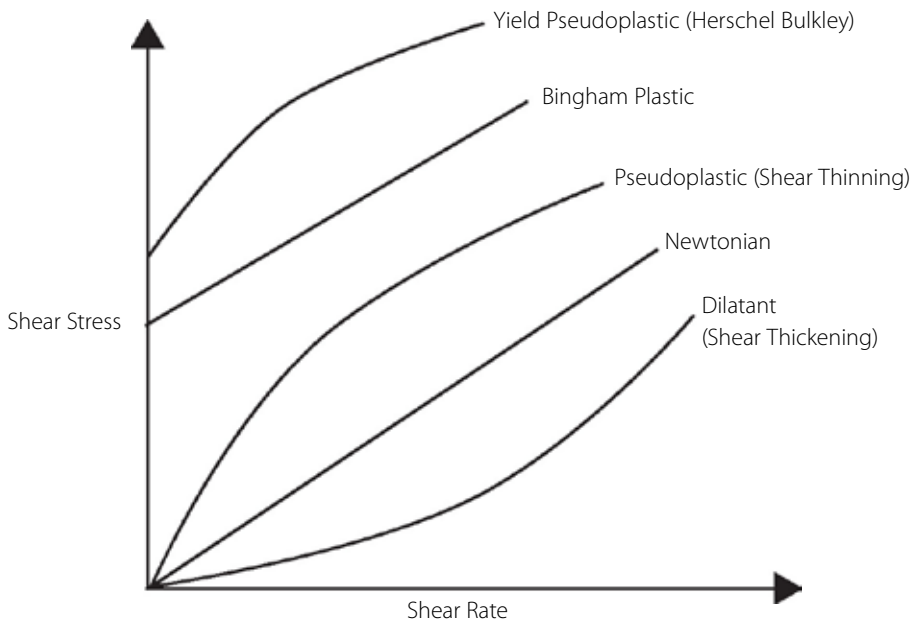

All non-Newtonian behaviors are not time independent, see chart below. There are also some time dependent non Newtonian fluids: rheopectic fluids increase in viscosity with time for a given energy input, (e.g. bentonite and other hydrophilic slurries), and thixotropic fluids decrease in viscosity with time (e.g. non-drip paint).

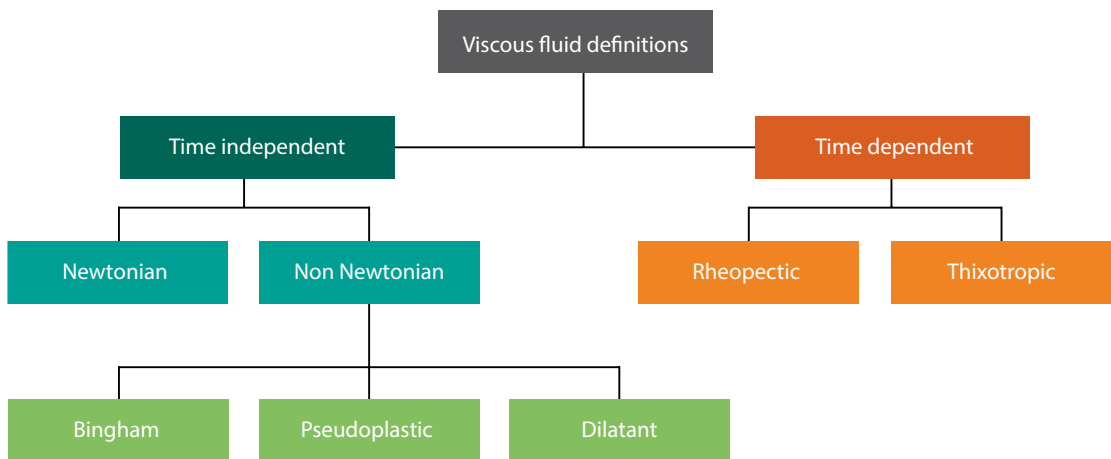

Calculations for non-Newtonian slurries are complicated and can easily result in sizing errors. Contact Metso Outotec Proposal Support for assistance regarding effects on pump performance because of the complex behavior of non-settling viscous slurries.



# 12. Best Efficiency Point (BEP)

The hydraulic performance of a slurry pump naturally affects the mechanical load on various parts of the pump design.

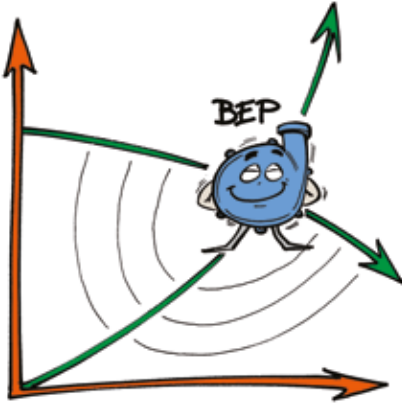

For all centrifugal slurry pumps there is only one operating point which is really ideal for the particular slurry pump involved - the Best Efficiency Point (BEP).

This point is located at the intersection of the best efficiency line and the line relating differential head to volumetric flow rate at a particular pump speed.

**BEP** – the optimal operating point for the pump.

## Hydraulic effect of efficiency point operation

To fully understand the importance of operating at (or close to) the best efficiency point, we have to study the



*Below BEP operation*

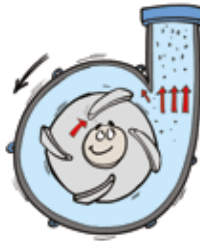

*BEP operation*

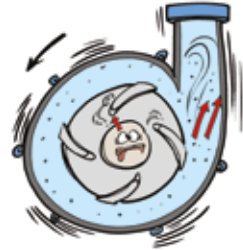

*Over BEP operation*

hydraulic behavior in the pump.

Looking at the hydraulic effects shown by the sketches, the following factors describe their impact on the design of slurry pumps.

### Radial load

Within a centrifugal pump casing there are unbalanced pressures acting on the impeller, causing the pump shaft to deflect. In theory, this radial force applied to the impeller is negligible at the best efficiency point (BEP). At increased speed and flows, both above and below BEP, the radial force increases significantly.

### Axial load

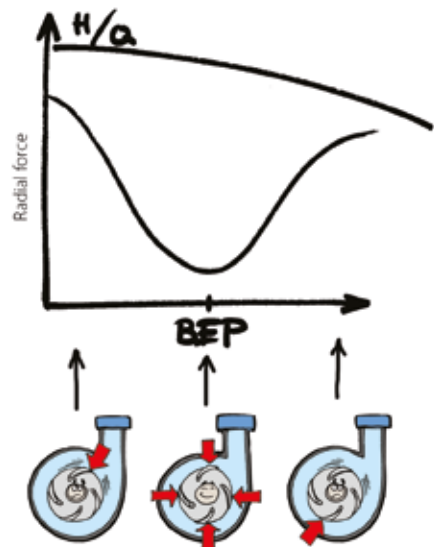

Pressure distributed on the front and back shrouds of a pump impeller create an axial load towards the pump inlet. For slurry pumps which are of end suction type, the inlet pressure acting on the shaft cross-sectional area creates an axial load away from the pump inlet. The summation of these two forces gives a resultant axial load on the shaft. With a low inlet pressure (head), this net force acts towards the pump inlet, but with vanes on the back shrouds, this force is normally balanced. As the inlet head increases, the force acts away from the pump inlet.

### Effects of shaft deflection

Varying impeller loads cause the impeller and shaft to deflect. This shaft deflection has an adverse effect on the shaft sealing as well as bearing life. Excessive shaft deflection will cause mechanical seals to fail and packed stuffing boxes to leak.

As shaft packings not only seal a stuffing box, but act as a hydrodynamic bearing, excessive shaft sleeve wear could also occur following operation under high radial load / shaft deflection.

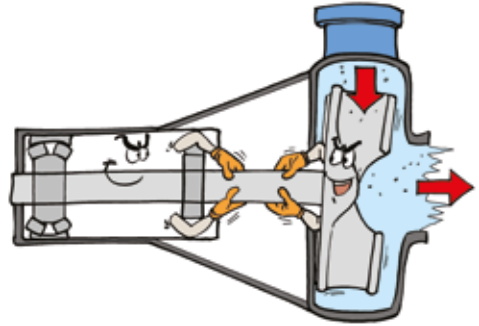

### Operating at BEP – summary

Selection of a pump that operates at or very near its BEP is preferable, although not always possible with a limited range of pumps.

At BEP, radial load and shaft deflection are at a minimum, thereby ensuring good shaft seal and bearing life.

Power absorbed is at a minimum and smooth hydraulic flow is assured.

For slurry pumps, the minimum turbulence and recirculation at BEP equates to minimum wear.

The figure below illustrates this observation.

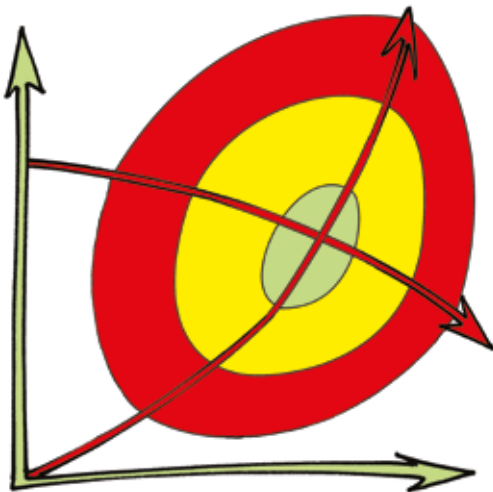

- Green zone - Ideal for minimum wear
- Yellow zone - Increasing rate of wear
- Red zone - Best avoided
- Note that zones become smaller as head and speed increase

# 13. Technical description

## General

If you look at a breakdown of the relative operating costs for a average slurry pump installation you will find the factors that guide our design of slurry pumps.

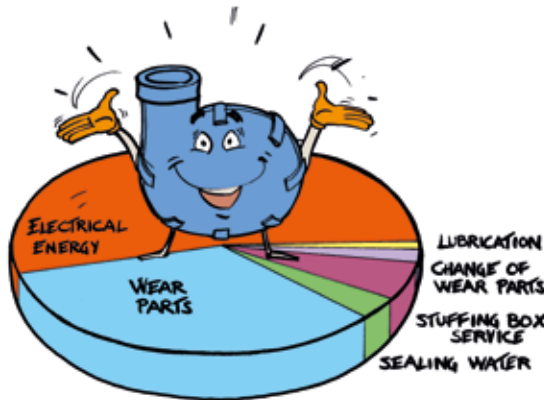

- High efficiency and minimised solids effect on efficiency drop giving lower power consumption
- New wear materials, both elastomers and metal, of good design giving long life for wear parts
- Service features in the design giving short shut down cycles and low maintenance costs
- Modern sealing designs giving low down time and costs for shaft sealing

## Nomenclature

Series	Description - Horizontal pumps
MDM	<b>M</b> ill <b>D</b> ischarge Pump with <b>M</b> etal Parts
MDR	<b>M</b> ill <b>D</b> ischarge Pump with <b>R</b> ubber Parts
XM	<b>EX</b> tra Heavy Duty Slurry Pump with <b>M</b> etal Wear Parts
XR	<b>EX</b> tra Heavy Duty Slurry Pump with <b>R</b> ubber Wear Parts
XG	<b>EX</b> tra Heavy Duty <b>G</b> ravel Pump
HM	<b>H</b> eavy Duty Slurry Pump with <b>M</b> etal Wear Parts
HR	<b>H</b> eavy Duty Slurry Pump with <b>R</b> ubber Wear Parts
HG	<b>H</b> eavy Duty <b>G</b> ravel Pump
HH	<b>H</b> igh <b>H</b> ead/ <b>P</b> ressure Pump with <b>M</b> etal Wear parts
HP	<b>H</b> eavy Duty High <b>P</b> ressure Pump
HT	<b>H</b> eavy Duty <b>T</b> unneling Pump
MM	<b>M</b> ining Duty Slurry Pump with <b>M</b> etal Parts
MR	<b>M</b> ining Duty Slurry Pump with <b>R</b> ubber Parts
Thomas	Dredge Pump
VASA HD	<b>H</b> eavy <b>D</b> uty

Series	Description - Vertical pumps
VF	<b>V</b> ertical Slurry Pump – <b>F</b> roth type with metal or rubber parts
VS	<b>V</b> ertical Slurry Pump – <b>S</b> ump type with metal or rubber parts
VT	<b>V</b> ertical Slurry Pump – <b>T</b> ank type with metal or rubber parts
VSHG	<b>V</b> ertical Slurry Pump – <b>S</b> ump type, <b>H</b> eavy Duty <b>G</b> ravel wet-end
VSHM	<b>V</b> ertical Slurry Pump – <b>S</b> ump type, <b>H</b> eavy Duty with <b>M</b> etal parts
VSHR	<b>V</b> ertical Slurry Pump – <b>S</b> ump type, <b>H</b> eavy Duty with <b>R</b> ubber parts
VSMM	<b>V</b> ertical Slurry Pump – <b>S</b> ump type, <b>M</b> ining Duty with <b>M</b> etal parts

## Metso Outotec slurry pump series and sizes

Pump size – inlet flange

Inlet size (mm) (inch)	50 2	75 3	100 4	150 6	200 8	250 10	300 12	350 14	400 16	450 18	500 20	550 22	600 24	650 26	700 28	800 32
<b>Metso Outotec MD series</b>																
MDM						■	■	■	■	■	■	■		■	■	
MDR						■	■	■	■	■	■	■				
<b>Orion series</b>																
MM			■	■	■	■	■	■			■					
MM - WFR			■	■	■		■	■								
MR							■	■			■					
HM	■	■	■	■	■	■	■									
HM - WFR	■	■	■	■		■										
HR	■	■	■	■	■	■										
HH					■											
HG			■	■		■										
HG - WFR			■	■												
HP			■	■	■	■										
HT				■	■											
<b>Thomas series</b>																
XM								■	■		■		■		■	
XR							■	■	■							
Thomas Dredge				■	■	■	■	■	■	■	■		■			■
<b>Sala series</b>																
VSMM			■	■	■	■	■	■	■							
VSMM - WFR			■	■	■		■	■								
VSHM	■	■	■	■	■	■										
VSHM - WFR	■	■	■	■		■										
VSHR	■	■	■	■	■	■										
VSHG			■	■		■										
VSHG - WFR			■	■												

Pump size – outlet flange





Outlet size (mm) (inch)	25 1	40 1,5	50 2	80 8	100 4	150 6	200 8	250 10	300 12	350 14
<b>Sala series</b>										
VS	■		■	■	■	■	■	■		
VT		■	■	■	■	■	■	■		
VF			■	■	■	■	■	■		■
VASA HD					■	■	■			

## Metso Outotec horizontal slurry pump wet-end modular configurations

Pump Type & Frame												
Frame	250	300	400	500	600	750	900	1000	1200	1400	1600	2100
Pump												
MM	100	150	200	250	300, 350	400	500					
MR					300	350		500				
HM	50, 75	100	150	200	250	300						
HR	50, 75	100	150	200	250	300						
HP	75	100	150	200	250							
HT	100	150										
HG		100	150		200, 250							
HH					200							
XG						250		350				
XM							350	400	500	600, 700		
XR						300	350	400				
MDM						250	300	350	400, 450	500, 550	650, 700	800, 900
MDR						250, 300	350		400, 450	500, 550	650, 700	

## Metso Outotec vertical slurry pump wet-end modular configurations

### Frame and wet end modular configurations Sala-series

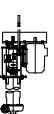
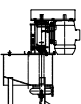
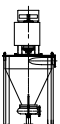
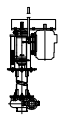
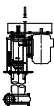
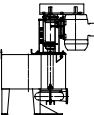
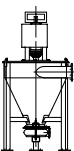
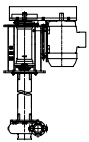
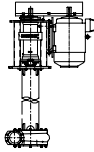
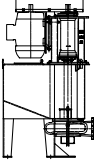
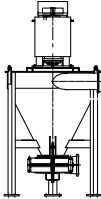
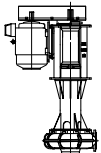
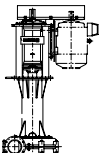
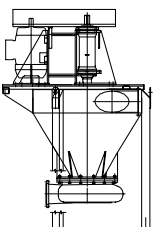
VSHM, VSHR, VSMM	VS RANGE	VT RANGE	VF RANGE	Frame size
		 VT40		<b>VA</b>
	 VS25 L80 VS50 L80 VS80 L80 VS100 L80	 VT50	 VF50	<b>VB</b>
	 VS25 L120-180 VS80 L80 VS100 L80	 VT80 VT100	 VF80	<b>VC</b>
 L120 - 180 VSHM50 VSHR50 VSHM75 VSHR75 VSHM100 VSHR100 VSMM100 VSMM150	 VS50 L120-180 VS80 L120-180 VS100 L120-180 VS150 L120	 VT150	 VF100 VF150	<b>VD</b>
 L120 - 180 VSHM150 VSHR150 VSHM200 VSHR200 VSMM200 VSMM250	 VS150 L150-180 VS200 L120-180	 VT200 VT250	 VF200 VF250	<b>VE</b>
 VSHM250 L120-180 VSHR250 L120-180 VSMM300 L120-180 VSMM350 L150-180	 VS250 L150-180			<b>VF</b>
			 VF350	<b>VG</b>

## Slurry pump range MD

### Mill Discharge slurry pumps: MDM and MDR

Specifically designed from its inception for mill circuit applications, the Metso Outotec MD series of mill discharge MDM hard metal and MDR rubber lined slurry pumps offer sustained performance with maximum time between mill shutdowns.

Hydraulic design is consistent across the entire range and by limiting the inlet velocity at design BEP impact damage from coarse heavy solids is kept to an absolute minimum.

Large diameter high aspect ratio impellers provide for excellent hydraulic efficiency with minimum turbulence at minimum rotational speed, thereby reducing the rate of wear.

Reduced impeller overhang restricts shaft deflection across a wide range of flows, and in so doing maximizes shaft seal and radial bearing life.

Suction side recirculation is restricted by an adjustable inlet liner/wear plate. When used in conjunction with the axially adjustable bearing cartridge, the design provides for 'double adjustment' ensuring that both suction side and gland side impeller clearances can be set and reset at a minimum.

#### Summary of design features

- High sustained efficiency
- Even hydraulic wear
- Longer operating life
- Oversized robust steel shaft
- Extra thick casings and liners at known points of wear
- Back pull-out option for ease of maintenance
- Self-contained oil or grease lubricated bearing cartridge assembly with noncontact labyrinth seals for maintenance free operation
- Bearing housing arranged to accept temperature and vibration sensors
- Split stuffing box gland and gland guard
- Various shaft seal options including Metso Outotec EnviroSet™
- Modular design with good interchangeability of parts
- Loose steel connection

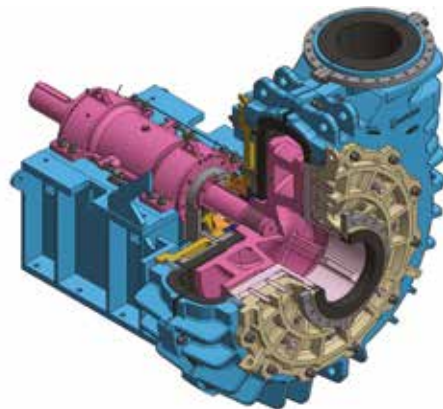
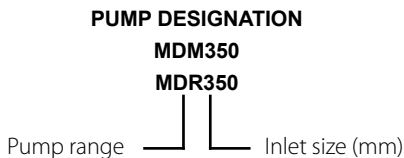

## Slurry pump range XM

### The Thomas series of Extra Heavy Duty Hard Metal slurry pumps

The XM (hard metal), Extra Heavy Duty slurry pump range is designed for the most arduous pumping applications. The rugged wet end is designed with extra thick metal sections at known points of wear and the high aspect ratio impeller ensures excellent performance with long wear life.

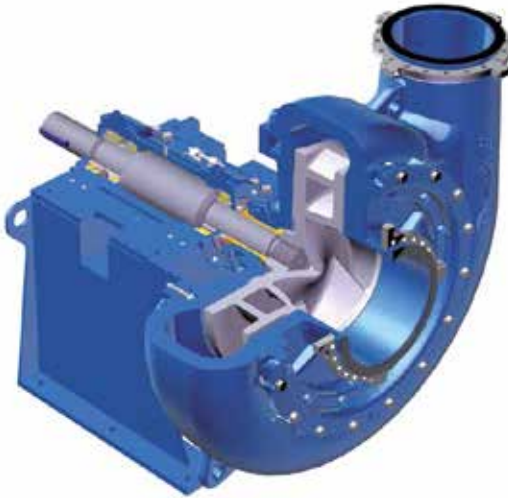

#### Summary of design features

- Modular design technology
- Robust construction designed for highly abrasive, maximum duty
- Thick volute casings and heavy duty solids handling impellers, with high aspect ratio, and carefully matched, high efficiency, hydraulics for even wear
- Materials used are the very best available, providing both excellent wear properties and corrosion resistance
- Self contained bearing cartridge assembly with oversized shaft and grease/oil lubricated antifriction bearings
- Various shaft seal options
- Ease of maintenance
- Maintenance slide base option

#### PUMP DESIGNATION

**XM350**

Pump Range  Inlet size (mm)



## Slurry pump range XR

### The Thomas series of Extra Heavy Duty Rubber Lined Slurry Pumps

The XR (rubber lined), Extra Heavy Duty slurry pump range is designed for the most arduous pumping applications. The rugged wear end is designed with extra thick rubber sections at known points of wear and the high aspect ratio metal impeller, also available in rubber, ensures excellent performance with long wear life.

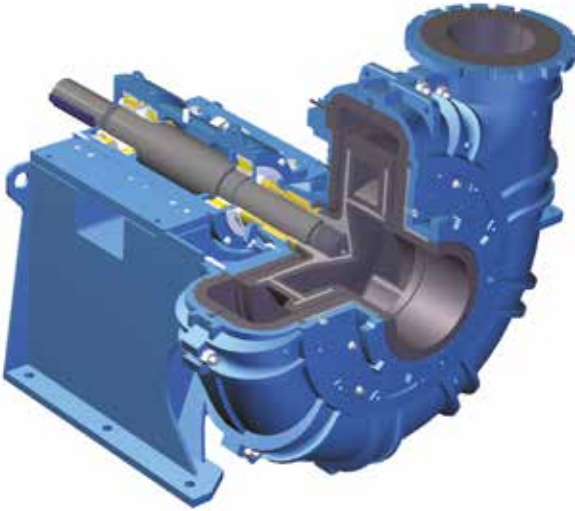

#### Summary of design features

- Modular design technology
- Robust construction, with back pull-out feature, designed for highly abrasive, maximum duty, and aggressive environments
- Thick volute casing liners and heavy duty solids handling impellers with high aspect ratio, and carefully matched, high efficiency, hydraulics for even wear
- Materials used are the very best available, providing both excellent wear properties and corrosion resistance.
- Self-contained bearing cartridge assembly with oversized shaft and grease lubricated antifriction bearings
- Various shaft seal options
- Maintenance slide base option
- Ease of maintenance

#### PUMP DESIGNATION

**XR350**

Pump Range **XR** Inlet Size (mm) **350**

## The Thomas series of Simplicity Dredge pumps

The Thomas "Simplicity" dredge pump is engineered for your specific operation. Years of operation and many design improvements have resulted in a pump which will give you lowest operating cost of any pump in the industry when handling abrasive materials.

The rugged wet-end parts are designed to feature extra heavy metal sections at points of extreme wear — the extra weight pays off in performance and low maintenance cost.

No other dredge pump manufacturer offers the wide range of wear resistant alloys as provided by Metso Outotec. Matching the correct alloy to your specific application will give you the best performance and lowest cost.

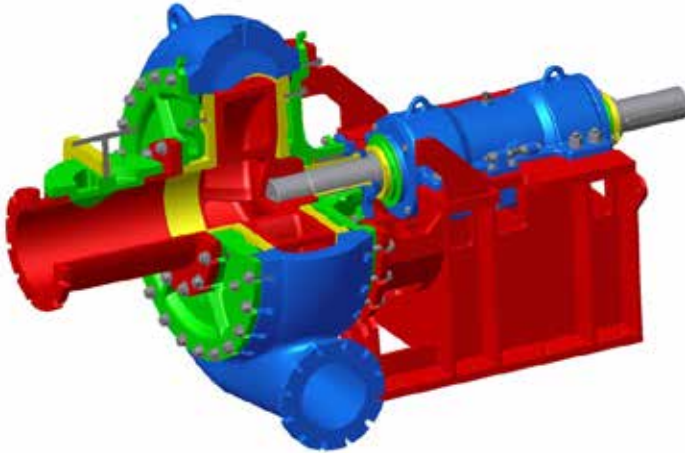

### Summary of design features

- Optional rotation — Right or left hand rotation
- Optional discharge positions
- Suction adapter with clean out
- Three and four vane impellers available
- Amor-lok seal on the side liners for metal to metal fit
- Knock out ring for easy impeller removal
- Wide range of alloys for pump wear parts
- Over size bearings and shaft for longer life
- Cantilevered design
- Reduced shaft deflection
- Better packing and bearing life
- 360° crescent support
- No case feet required

## The Orion series of Heavy Duty Rubber Lined and Hard Metal slurry pumps type HR and HM

The HR (rubber lined) and HM (hard metal), Heavy Duty slurry pump ranges are designed for the toughest pumping applications. The excellent hydraulic design, with extra thick sections at known points of wear and the high aspect ratio impeller ensure excellent performance with long wear life.

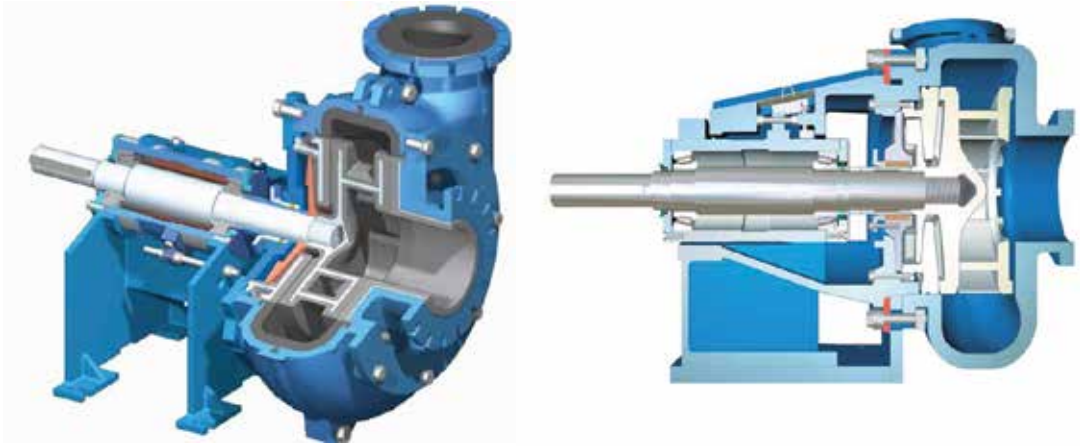

*HR wet end single adjust, HM wet end double adjust*

### Summary of design features

- Modular design technology and back pull-out feature
- Robust construction
- Thick volute casing/liner and solids handling, large diameter, impeller with carefully matched, high efficiency, hydraulics for even wear
- Double adjustment for sustained efficiency
- Materials used are the very best available, providing both excellent wear properties and corrosion resistance
- Self-contained bearing cartridge assembly with oversized pump shaft and antifriction bearings
- Various shaft seal options
- Ease of maintenance
- Maintenance slide base option

### PUMP DESIGNATION

HR or HM100

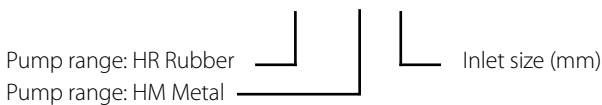

## The Orion series of Mining Duty Rubber Lined and Hard Metal slurry pumps type MR and MM

The MR (rubber lined) and MM (hard metal) mining duty, slurry pump ranges are designed to provide an economical solution to all slurry pump applications. Excellent hydraulic designs maximise efficiency throughout the life of the pump and selection of wear part materials from the extensive Metso Outotec ranges of metals and elastomers ensure long wear life.

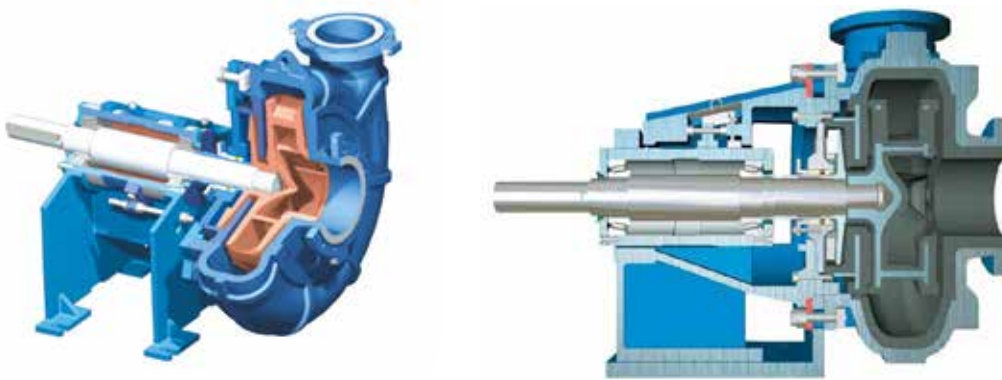

MM wet end single adjust, MR wet end double adjust

### Summary of design features

- Modular design technology and back pull-out feature
- Robust construction
- Solids handling, medium diameter impeller with carefully matched, high efficiency, hydraulics for even wear
- Double adjustment for sustained efficiency
- Materials used are the very best available, providing both excellent wear properties and corrosion resistance
- Self contained bearing cartridge assembly with oversized pump shaft and grease lubricated taper roller bearings
- Various shaft seal options
- Ease of maintenance
- Maintenance slide base option

### PUMP DESIGNATION

MR or MM100

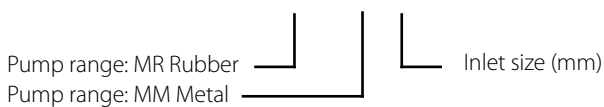

## The Sala series of Vertical Tank pumps VT

Metso Outotec's tank pumps are designed for abrasive slurry service and feature simple maintenance and robust design.



### Summary of design features

- Pump, tank, and motor in one integrated unit for flexible layout and simple installation
- Open sump and vertical inlet prevents air blocking and gives a smooth operation
- Oversize bearings for added life and minimum maintenance. Double protection sealing arrangement against penetration of slurry.
- Cantilever shaft with no submerged bearings or seals. Shaft made of alloy steel for superior strength and toughness
- Easily replaced wear parts and metal/rubber interchangeability

### PUMP DESIGNATION

VT100

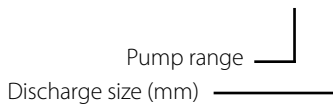

## The Sala series of Vertical Froth pumps VF

Metso Outotec's froth pumps are designed to increase the pumpability of frothy suspensions. The principal of operation is similar to that of hydrocyclone separation.

Air is separated from the slurry in a vortex created by the impeller rotation and the tangential inlet to the pump's conical sump. This results in a more efficient pumping at higher capacities and a smooth operation free from fluctuations.



### Summary of design features

- Conical pump tank and motor in one integrated unit for flexible layout and simple installation
- Vertical inlet prevents air blocking
- Oversize bearings for added life and minimum maintenance. Double protection sealing arrangement against penetration of slurry
- Cantilever shaft and made of alloy steel for superior strength and toughness, with no submerged bearings or seals
- Easily replaced wear parts and metal/rubber interchangeability

### PUMP DESIGNATION

**VF100**

Pump range — | — | Outlet size (mm)

## The Sala series of Vertical Sump pumps VS

Metso Outotec sump pumps are designed specifically for abrasive slurries and feature robust design with ease of maintenance.

The VS sump pump range is one of the strongest, toughest and reliable high volume ranges available on the market.



### Summary of design features

- Simple installation
- Cantilever design without submerged bearings or shaft seal
- Bearing assembly with double protection sealing arrangement to prevent ingress of slurry
- Materials used are the very best available, providing both excellent wear properties and corrosion resistance
- Wear parts are available in a variety of different materials with full interchangeability
- Range of impeller options

### PUMP DESIGNATION

**VS100 L120 O4S**





## The Sala series of Vertical Sump pumps VSHM, VSHR/VSMM

The VSH and VSM pumps are a new combination of our classic VS sump pumps and our Orion series horizontal pump wet ends. This provides a major advantage to the customer: the same wet end parts are used for both horizontal slurry pumps and sump pumps, thus reducing parts inventory and simplifying maintenance. It does also make it possible to generate a higher TDH, pump head.

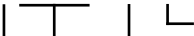

### PUMP DESIGNATION

**VSHM150 L120 C5**

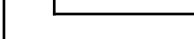
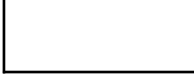
-  5 vane closed impeller
-  Frame length (cm)
-  HM150 is the horizontal pump wear parts (150 is the inlet size, mm)
-  Pump range



# 14. Application Guide

## General

This section is a guide to the selection of the correct slurry pump range for various applications. As previously stated the sizing of the slurry pump and its system is very important. Equally important is to choose the right type of slurry pump for the process application in question. The slurry pump range presented in this handbook represents a broad coverage of applications for hydraulic transport of solids.

Selecting against duty means selecting pumps considering parameters like:

- Volumetric flow rate
- Head
- Solids
- Liquid

## Selection by duty or industrial application?

How to pump

- Industrial waste
- Leaching residue
- Mill scales
- Mineral tailings
- Wood chips
- etc.

How to feed

- Hydrocyclones
- Pressure filters
- Tube presses
- Flotation machines
- etc.

To be as practical as possible, this application guide is divided in two parts.

### Selection by duty

In this section we are selecting the optimal slurry pump simply against the specified pump duty. This guide is strictly based on technical performance reflecting various Solid/Liquid parameters.

### Selection by industrial applications

This section is more of a practical guide, based on experience from our customers day to day applications, working in very different industrial environments.

This guide is structured from practical experience in the hydraulic transportation of solids within the following industrial segments:

- Mineral (Metallic & industrial)
- Construction
- Coal
- Waste & recycling
- Power & FGD
- Pulp & paper
- Metallurgy
- Chemical
- Mining & tunnelling

## Selection - by solids

### Duty: Coarse particles

**Comments:** Everything larger than 5 mm is considered to be coarse. Do not use rubber pumps, metal pumps only. Upper practical limit in particle size is normally 50 mm and the limitation is the impact on the impeller.

**Note:** Particle diameter max. 1/3 of the pipe diameter.

**Recommendation:** MDM, XM and HM ranges.

### Duty: Fine particles

**Comments:** If the particles are fine and sharp - use rubber. If particles are fine and smooth - use rubber or metal.

**Recommendation:** H and M ranges.

### Duty: Sharp (abrasive) particles

**Comments:** If sizes are below 5 mm - use rubber. If particles are above 5 mm - use metal.

**Recommendation:** MD, X, H and M ranges.

### Duty: High percent solids

**Comments:** You have to be careful if the percent solids is getting close to 40 % by volume. Above 50 %, the slurry is impossible to handle with centrifugal pumps.

### Duty: Low percent fine solids

**Comments:** Choose the lightest and most cost effective pumps.

**Recommendation:** M range.

### Duty: Fibrous particles

**Comments:** The problem is blocking of particles and air blocking. Use induced flow impellers (Vortex).

**Recommendation:** H and V range.

### Duty: One size particles

**Comments:** When all fine particles are removed from the slurry the solid settling rate can be critical and can call for severe derating of the pump. Pumping efficiency goes down for all pump types.

**Recommendation:** All pump ranges.

## Duties related to head and volume

### Duty: High head

**Comments:** Normally metal pump applications due to the high peripheral speed on the impeller. If you need rubber lined pumps, series pumping may be needed, see page 52.

Max. head on hard metal pump 125 m (410 ft).

Max. head on rubber impeller 45 m (148 ft).

**Note:** High rate of wear at high speeds for centrifugal pumps.

**Recommendation:** XM, XR and HP, or staged HR.

### Duty: Varying head at constant flow

**Comments:** Use a multi-speed drive or a variable (frequency control) drive.

**Recommendation:** All ranges.

### Duty: Varying flow at constant head

**Comments:** Use variable (frequency control) drives.

**Recommendation:** All ranges.

### Duty: High suction lift

**Comments:** Metal pumps are preferred due to risk of rubber lining collapse on high suction lifts.

Max. practical suction lift 5 - 8 m (16 - 26 ft) depending on S.G.

Pumps are not self-priming, i.e. you need a priming device.

The pump and inlet pipe need to be filled with liquid before starting.

**Recommendation:** XM, HM and MM.

### Duty: High flow

**Comments:** Use parallel pump installations, see page 53. Risk for cavitation, see Chapter 10.

**Recommendation:** All ranges.

### Duty: Low flow

**Comments:** Compare to BEP\*, see Chapter 12.

At low flows, rubber linings can overheat. Use metal.

Be careful if heads are high and flow is low.

Open vertical pumps have no problems.

\*BEP = Best Efficiency Point

**Recommendation:** Try to use VS, VT and VF ranges.

### Duty: Fluctuating flow

**Comments:** Use horizontal pumps with variable speed drive or fixed speed vertical pumps.

**Recommendation:** VT, VF or VS. Horizontals; all types with variable speed drives.

## Duties related to slurry type

### Duty: Fragile slurries

**Comments:** Use induced flow impellers (fully recessed). Both metal and rubber pumps can be used. Both horizontal and vertical pumps can be used.

**Recommendation:** All ranges.

### Duty: Hydrocarbon slurries (oil and reagents contaminated)

**Comments:** Natural rubber is not recommended. Be careful with seal material of natural rubber. Use synthetic seals. Use metallic pumps or wear parts in polyurethane.

**Recommendation:** All ranges.

### Duty: High temperature (greater than 100 °C (212 °F)) slurries

**Comments:** Metso Outotec slurry pumps are designed for use with non-hazardous liquids at temperatures below 100 C (212 F). See Chapter 6 for elastomer temperature limits.

**Recommendation:** All ranges.

### Duty: Frothy slurries

**Comments:** Use a froth pump of vertical or horizontal design.

**Recommendation:** VF range.

### Duty: Hazardous slurries

**Comments:** Normally closed pump systems are used. Contact Metso Outotec Proposal Support.

**Recommendation:** Horizontal ranges.

### Duty: Corrosive slurries (low pH)

**Comments:** For acidic duties use rubber or elastomer.

Sea water slurries (containing chlorides) must have a rubber pump or 30% chromium.

**Note:**  $\text{CuSO}_4$  (used in flotation circuits) is extremely corrosive, use rubber pumps.

**Recommendation:** All ranges.

### Duty: High viscosity fluids (Newtonian)

**Comments:** Pumping becomes critical when viscosity gets up to 5 times the viscosity of water. With this restriction basically any pump in our range can be used, if properly sized.

**Recommendation:** All sizes.

### Duty: High viscosity fluids (non-Newtonian)

**Comments/Recommendation:** These applications are complex and should be referred to Metso Outotec Proposal Support.

## Duties related to mixing

### Duty: Mixing

**Comments:** Tank pumps are excellent as mixers. When mixing water and solids, look up the correct ratio between liquid and solids.

**Recommendation:** VT and VF range.

## Selection of slurry pumps - by industrial application

This selection guide is based on practical experience from slurry pump applications within the following industrial segments:

- Metallic and industrial minerals
- Construction
- Coal
- Waste & recycling
- Power & FGD
- Pulp & paper
- Metallurgy
- Chemical
- Mining & tunnelling

## Industrial segment: Metallic & industrial minerals

### Application: Pumps for grinding circuits

**Comments:** Our ranges MD, X, and H are specially designed for grinding circuits (incl. cyclone feed). For particles sizes below 5 mm, use rubber. If possible, mix flows containing coarse and fine particles together for better slurry stability.

**Recommendation:** MDR/MDM, XR/XM, and HR/HM.

### Application: Pumps for froth

**Comments:** The VF range is specially designed for froth pumping with heads up to 20 m (65 ft).

**Recommendation:** VF.

### Application: Pumps for floor sumps

**Comments:** Use sump pumps type VS with metallic wear parts, since there often is a risk for oversize tramp material coming into floor sumps. If rubber must be used, put a strainer in front of the pump or around the pump.

**Recommendation:** VS range.

### Application: Pumps for tailings

**Comments:** Depending on particle size, both rubber and metal pumps can be used. For long distances installations (in series), see Chapter 11 - Slurry Pump Systems.

**Recommendation:** X and H ranges, both rubber and metal.

### Application: Pumps for hydrocyclone feed

**Comments:** For sharp classification, use horizontal pumps type MD, X, or H. For dewatering cyclones, use tank pumps.

**Recommendation:** MD, X, H, and VT ranges.

### Application: Pumps for pressure filter feed

**Comments:** High head needed with variable speed control (alternatively two-speed drive). Avoid rubber due to low flow heat build up. Narrow impellers preferred to reduce shaft loads.

**Recommendation:** HM range.

### Application: Pumps for tube press feed

**Comments:** Small flow and high head, use metal pumps of type HM. One pump can feed many tubes by a slurry distribution ring.

**Recommendation:** HM range.

### Application: Pumps for leaching

**Comments:** See corrosive slurries, page 80.

### Application: Pumps for dense media (heavy media)

**Comments:** High inlet head and high percent solids in combination with low discharge head can cause expeller seal leakage problems.

**Recommendation:** HM range.

### Application: Pumps for general purpose (mineral)

**Comments:** Horizontal pumps of type MM and MR are ideal for normal duty in mineral process circuits. If the wear is extreme, use the X and H ranges. Rubber is normally preferred in hard rock concentrators. For special applications, use the vertical pumps.

**Recommendation:** All ranges.

## Industrial segment: Construction

### Application: Pumps for wash water (sand and gravel)

**Comments:** Normally, the vertical pumps type VS and VT are used. Horizontal pump of the M range is also suitable.

**Recommendation:** V and M range.

### Application: Pumps for sand transportation

**Comments:** Horizontal pumps with rubber lining are preferred.

**Recommendation:** HR.

### Application: Pumps for tunnel dewatering

**Comments:** For the first transportation stage, vertical pump type VS is normally used. For horizontal distant pumping, use HM range. For cuttings from full face boring (tunnel boring machines) use HM and MM pumps. For small tunnels (micro bore) use small HM or HT tunnel pumps.

**Recommendation:** H, M, and VS range. (No rubber due to oil.)

## Industrial segment: Coal

### Application: Pumps for coal washing

**Comments:** Generally metal pumps are used because of risk for oversized tramp material.

**Recommendation:** HM, MM, and XG ranges.

### Application: Pumps for froth (coal)

**Comments:** Use vertical pump type VF or MM.

**Recommendation:** VF.

### Application: Pumps for dense media (coal)

**Comments:** See dense media, page 78.

### Application: Pumps for general purpose (coal)

**Comments:** Coal industry normally does not use rubber pumps.

**Recommendation:** Use HM and MM.

## Industrial segment: Waste & recycling

### Application: Pumps for effluent handling

**Comments:** Light-duty application. Use either horizontal or vertical pumps. Metal pumps is the first selection.

**Recommendation:** HM, MM, and V ranges.

### Application: Hydraulic transportation of light waste

**Comments:** Use horizontal pumps with Vortex induced flow impellers.

**Recommendation:** HM and MM ranges.

### Application: Pumps for soil treatment

**Comments:** See minerals above. Pump type VT are recommended for mobile and semi-mobile plants (no leaking seal and easy to transport and install).

**Recommendation:** All ranges.

## Industrial segment: Power & FGD

### Application: Pumps for FGD reactor feed (Absorber Recycle)

**Comments:** Normally the mineral applications use X, H, and M ranges, all with rubber and/or metal parts. Rubber for high chloride concentrations.

**Recommendation:** X, H, and M ranges.

### Application: Pumps for FGD reactor discharge (Absorber bleed)

**Comments:** See lime pumps above.

**Recommendation:** X, H, and M ranges

### Application: Bottom ash pumping

**Comments:** Metal pumps are preferred due to temperature and particle size. Use horizontal pumps of type X and H.

**Recommendation:** XM and HM or HP ranges.

### Application: Fly ash pumping

**Comments:** Metal is normally used due to risk of oil contamination. If rubber must be used (low pH), look out for any oil or other chemicals.

**Recommendation:** X, H, M, and VS ranges.

## Industrial segments: Pulp & paper

### Application: Pumps for liquors

**Comments:** On black liquors, rubber is not to be recommended (due to risk of turpentine).

**Standard recommendations:** H and M ranges (metal parts).

**Recommendation:** HM and MM range.

### Application: Pumps for lime and caustic mud

**Comments:** These applications are normally of high temperature. Therefore metal parts are recommended.

**Recommendations:** HM and MM.

### Application: Pumps for reject pulp (containing sand)

**Comments:** Normally light duty, but metal parts are recommended.

**Recommendation:** MM range.

### Application: Pumps for solids from debarking

**Comments:** For sand and bark, we have developed an extra long vertical pump type VS.

Use metal parts and induced flow impeller (Vortex).

**Recommendation:** VS range.

### Application: Pumps for hydraulic transportation of wood chips

**Comments:** Use induced flow pumps (Vortex) of H and M type.

**Recommendation:** HM and MM ranges.

### Application: Pumps for paper filler and coating slurries

**Comments:** No rubber allowed due to colour contamination.

**Recommendation:** HM, MM, VS, and VT ranges. (Only metal parts.)

### Application: Floor spillage pumps

**Comments:** Use a vertical pump of type VS. Contact Metso Outotec Proposal Support if low pH.

**Recommendation:** VS range.

## Industrial segment: Metallurgy

### Application: Pumps for mill scale transportation

**Comments:** First choice is vertical pump type VS with induced flow impeller and metallic parts. Horizontal pumps use type HM with metal parts only.

**Recommendation:** HM and VS ranges.

### Application: Pumps for slag transportation

**Comments:** Same considerations as for Mill Scale above.

### Application: Pumps for wet scrubber effluents

**Comments:** Normally we recommend pump of horizontal type H range or vertical pumps of VS range. If pH is very low, use rubber. If pH is very low and temperature is very high, use stainless steel parts or synthetic rubber.

**Recommendation:** HR and VS ranges.

### Application: Pumps for iron powder transportation

**Comments:** See dense media pumps above.

### Application: Pumps for machine tool cuttings

**Comments:** No rubber parts can be used due to oil. Vertical pump of type VS and horizontal pumps type M.

**Recommendation:** VS and MM.

## Industrial segment: Chemical

### Application: Pumps for acid slurries

**Comments:** First recommendation is horizontal pumps with rubber or stainless parts. For extremely abrasive slurries, use horizontal pump type HR.

**Recommendation:** MR and HR ranges.

### Application: Pumps for brines

**Comments:** Very corrosive applications. Can also be abrasive (crystals).

Polyurethane can be used to avoid crystallization on pump parts.

**Recommendation:** HM, HR, MM, MR, and VS (polyurethane parts).

### Application: Pumps for caustics

**Comments:** Both rubber and metal pumps can be used.

**Recommendation:** MM, MR, HM, and VS ranges.

## Industrial segment: Mining

### Application: Pumps for hydraulic back filling (with or without cement)

**Comments:** Watch out for deslimed tailings. Use horizontal pumps of type H or M with rubber or metal parts.

**Recommendation:** H and M ranges.

### Application: Pumps for mine water (with solids)

**Comments:** Normal recommendation is horizontal pumps type HM (multi stage if required). Watch out for corrosion.

**Recommendation:** HM or HP.



# 15. Pump sizing

Modern sizing procedures for slurry pumps are computerized and easy to handle, as in Metso Outotec's PumpDim™. It is important that we know the steps for sizing slurry pumps and the relationship between them, to ensure that these procedures are correctly understood. The following manual procedure is approximate and gives reasonable accuracy, except in extreme applications.

## The sizing steps

### Step 1.

Establish if the slurry/liquid is a:

- Clear liquid
- Non-settling (viscous) slurry (Particle size <50 micron)
- Settling slurry

### Step 2.

Set up the duty details. These vary depending on the type of liquid according to Step 1. Common details are:

- Flow or tonnage
- Static lift (head)
- Friction losses given or pipe system known/selected
- Chemical properties like pH value, content of chlorides, oil, etc.
- Other liquid/slurry details as below

#### Clear liquids

When clear water - no further liquid details are required. For other clear liquids the following is needed.

- Liquid S.G.
- Liquid dynamic viscosity.

### Slurries

For slurries, a number of details are required. According to the following formulas, certain combinations of these data are required to be able to calculate all of them.

Sm	= Slurry S.G.
Cv	= Concentration by volume %
Cw	= Concentration by weight %
S	= Solids S.G.
Q	= M <sup>3</sup> /H flowrate
tph	= Tonnes per hour (solids)

### Slurry formula

$$Sm = \frac{100 - Cv}{100 - Cw}$$

$$Sm = \frac{Cv(S - 1) + 1}{100}$$

$$Cv = \frac{Sm - 1}{S - 1} \times 100$$

$$Cv = 100 - [(100 - Cw) \times Sm]$$

$$Cw = 100 - \left[ \frac{100 - Cv}{Sm} \right]$$

$$Cw = \frac{100 \times S}{100 + (S - 1) \times Cv}$$

$$Q = tph \times \left[ \frac{1}{S} + \left( \frac{100 - 1}{Cw} \right) \right]$$

For **non-settling** (viscous) slurries, the plastic dynamic viscosity and max. particle size are required.

For **settling slurries**, max. and average particle sizes (d50) is required.

### Solids tonnage or slurry flow?

As a comment to the above formulas, it is very important to understand the difference between *percent solids by weight* and *percent solids by volume*.

Percent solids by weight is the normal way of explaining a slurry. For example, magnetite slurry, 4 percent solids by weight. Limestone slurry, 40 percent solids by weight. This is due to the practice that production in general is measured as tonnes (solids)/hour. For example, magnetite feed to the circuit is 300 tonnes/hour as a slurry 40 % by weight. Limestone feed to the circuit is 300 tonnes/hour as a slurry 40 % by weight. Magnetite feed to the circuit is 300 tonnes/hour as a slurry 40 % by weight. Limestone feed to the circuit is 300 tonnes/hour as a slurry 40 % by weight.

Since pumps are volumetric machines that are sized by flow, figures in terms of weight must be converted into figures in terms of volume.

If we look on the flow conditions of the above slurries we will find that: The magnetite slurry (with a solids S.G. of 4.6) gives a slurry flow of 515 m<sup>3</sup>/hour.

The limestone slurry (with a solids S.G. of 2.6) gives a slurry flow of 565 m<sup>3</sup>/hour.

As tonnage these capacities are equal, hydraulically they are not.

### Step 3.

For settling slurries only.

Check that the actual velocity in the pipe is higher than the critical velocity for stationary deposition. Refer to the diagram on page 50 using maximum particle size, solids S.G., and pipe diameter.

If a pipe diameter has not been specified, the best way to arrive at one is to select the first pipe size giving a velocity above 3 m/s. This pipe size should be checked to ensure that the actual velocity is greater than the critical velocity. Use the diagram on page 50 for velocities in different pipe diameters at a given flow.

If the actual velocity is less or greater than, the critical velocity, the exercise should be repeated for one size of pipe smaller, or larger, to check that you use the largest pipe possible to ensure that settling does not take place.

**Note:** Always use the minimum anticipated flow value to calculate the pipe velocity.

### Step 4.

Calculate total discharge head according to Chapter 11 - Slurry pump systems.

Additional process equipment needing pressure must also be considered. For hydrocyclones, the inlet pressure normally is specified in kPa or bar.

These figures have to be converted to head in meter slurry column (divide the pressure by the density of the fluid) and has to be added to the head calculated according to Chapter 11 - Slurry pump systems.

### Step 5.

The next step is to select wet end wear part material.

Select material from the max. particle size according to table on page 21. For clear liquids, metal pumps are the first choice. Check chemical resistance of the selected material from page 22.

### Step 6.

Now we have to select the right type of pump by considering the operating costs, taking into account wear, maintenance and energy. Depending on the application, it can be a horizontal or vertical slurry pump. It can also be a pump for extreme, heavy, or normal wear conditions.

From Chapter 16: Application Guide you can see which type of pump we recommend for various industrial applications. From this, together with the wet end material selected, you can select a suitable pump range from Chapter 15: Technical description. Now to the size of the pump. From previous steps above, we now know the slurry flow rate and total discharge head.

We now have to find the pump size for this duty. To be able to proceed and select a required pump speed and installed motor power, a complete clear water performance curve for the selected pump is required. If in doubt, contact Metso Outotec Proposal Support.

### Step 7

Since the pump performance curves are based on clear water, corrections are required if other liquids or a slurry is pumped.

Clear water

Mark your flow and total discharge head point on the upper section of the clear water performance curve according to the figure below.

# Metso:Outotec

## PUMP HM100 C5

### Performance curve

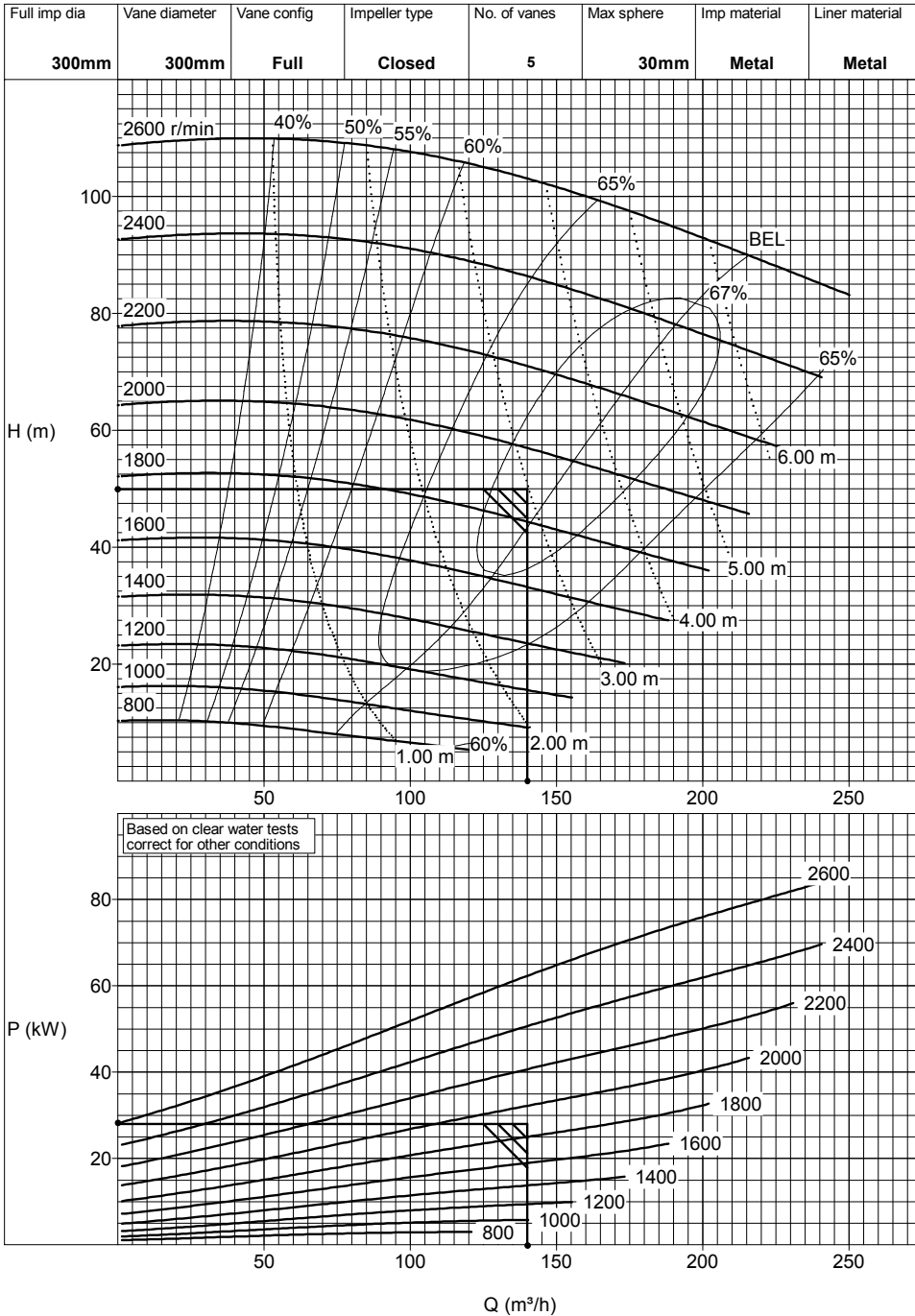

From this you can estimate the required pump speed or calculate it from the formula on page 36. According to the example above the speed is 1880 r/min.

Then take the required power from the lower part of the performance curve using the duty flow and speed rotation.

For settling slurries see diagram on page 37 using average particle size  $d_{50}$ , solids S.G. and concentration by weight. From this the HR/ER Factor can be established.

Divide the total discharge head by the HR factor. Since the factor is  $<1$ , the corrected total discharge head will get a higher value.

Mark your flow and corrected total discharge head point on the performance curve according to the figure under clear water.

From this you can estimate the required pump speed or calculate it from the formula on page 36.

Then take the required clear water power from the clear water performance curve. Multiply the power by the relative density.

Relative density = Slurry density / Clear water density

Then you have the required slurry power on the pump shaft.

For nonsettling slurries or viscous liquids, contact Metso Outotec Proposal Support.

## Check - for cavitation

According to Chapter 10: Hydraulic Performance we need to check also the hydraulic situation on the inlet side by calculating the **Net Positive Suction Head Available = NPSH<sub>A</sub>**

If the losses in the pump inlet pipe are too high (suction lift), the slurry has a high temperature, or the site is at a high altitude, we might get cavitation.

### Step 8

Next we have to select the correct motor size. It is recommended that a 15 % safety margin is added on to the required power. The next larger motor size available is selected.

### Step 9

Select a suitable drive to get the motor speed to meet the required pump speed. See Chapter 9: Drives for slurry pumps, for general guidelines. Contact drive suppliers or Metso Outotec Proposal Support for recommendations.

## Summary of sizing

The day to day tool for sizing slurry pumps is the PumpDim™ software. This basically follows the same sizing route as given above, but is simple and quick to use, and automatically carries out many mechanical checks such as bearing life, shaft deflection, and critical speeds.

# 16. Introduction to Metso Outotec PumpDim™

PumpDim™ is primarily a program for sizing and selecting Metso Outotec's pumps. It can size a pump for a specified duty point or a pipe system, pumping clear water, viscous liquids, or a suspension of solids in a liquid.

## Features

For settling slurries and manual calculations, Cave's correlation is the most common method of allowing for the effects of solids on pump performance. Later methods like the Metso Outotec method which include pump size effect are utilized when sizing software like PumpDim™ are used. These methods are more accurate and the Cave method is often too conservative.

## Pump performance with settling slurries

The results from PumpDim™ are representative for settling slurries with normal particle size and distribution, such as those found in mineral processing industries, with concentrations lower than 40 % by volume.

## Benefits

- Optimized to ensure maximum efficiency
- Ensure safe and reliable operation with maximum time between failure
- V-belt drive selection
- Pipe system sizing

- Critical flow velocity to avoid settling of particles in pipes
- The complete pipe head loss system curve when static head, pipes, fittings and other components are specified
- Pumping of froth when a froth factor is specified
- Effect of solids on the generated pump head and pump efficiency
- Recommends material for the pump wet end considering particle size and distribution
- Selects pump size for the specified duty and calculates required pump speed
- Calculates shaft deflection and bearing life at the duty point
- Recommends motor size and drive for the duty
- Calculates slurry density based on particle and liquid density and concentration and/or tonnage. Calculates actual flow through an existing installation based on pipe system, slurry properties, and pump speed i.e. determining circulating load in mill discharge applications

For example, the program considers and/or calculates the following parameters:

Homogenous slurries with particles essentially smaller than 50 µm i.e. clays, cement slurries, coating, and filler quality calcium carbonates that have a non-Newtonian behaviour, need to be treated as a viscous liquid. The true slurry plastic dynamic viscosity, yield stress, and flow index need to be known. These parameters can be established from test work carried out by Metso Outotec, or other laboratory.

For particles with a flaky or fibrous shape i.e. some mill shape, i.e. some mill scale applications and paper pulp applications, special considerations need to be made. If in doubt, contact Metso Outotec Proposal Support

- TDH
- Flow
- S.G slurry
- Slurry classification and related limitations according to Hydraulic Institute Slurry Pump standard
- Pump type
- Wet end wear material

### Copyright and guarantees

The program has been developed by Metso Outotec and remains our property at all times. It shall be returned upon request. The software is Metso Outotec's copyright and shall not be copied or passed to third parties without our written permission.

Any information gained from the software is advisory only, and implies no legal binding offer or warranty, unless confirmed by Metso Outotec. Any questions regarding the software shall be addressed to the local Metso Outotec office.

# 17. Motors

Electric motors are the most common driver used to power centrifugal pumps worldwide and the 3-phase AC squirrel cage induction motor is the most prevalent type in industrial applications.

In the Americas, users comply with standards set by the National Electrical Manufacturers Association (NEMA) for electrical products whereas in other parts of the world the standards are set by the International Electrotechnical Commission (IEC). Performance requirements are similar but motors are not directly interchangeable due to dimensional differences. Also, terminology describing motor characteristics is different.

Voltage and frequencies differ in regions of the world and motor selection must take this into consideration.

## Frame sizes

NEMA and IEC use letter and number codes to describe motor frame dimensions. However, the designated coding is not the same. Standard frame sizes for low voltage motors are listed by both organizations and motors above these sizes are considered to be special designs.

NEMA foot mounted motor with side mounted terminal box

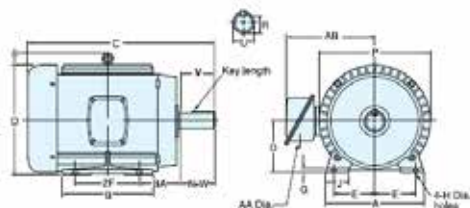

IEC foot mounted motor with overhead mounted terminal box

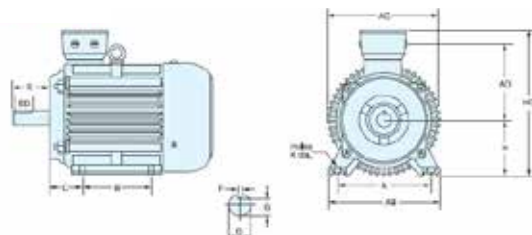

Sample chart comparing NEMA and IEC frame sizes  
(verify actual dimensions and ratings with motor manufacturers)

Frame	Dimensions (mms)							kW and HP ratings for 3Ø TEFC motors
	H D	A 2E	B 2F	C BA	K H	Ø D Ø U	E N-W	4 pole (1500/1800 rpm)
132S NEMA 213T	132 133.4	216 216	140 139.7	89 89	12 10.3	38 34.9	80 85.7	5.5 7.5
132M 215T	132 133.4	216 216	178 177.8	89 89	12 10.3	38 34.9	80 85.7	7.5 10
160M 254T	160 158.8	254 254	210 209.6	108 108	15 13.5	42 41.3	110 101.6	11 15
160L 256T	160 158.8	254 254	254 254	108 108	15 13.5	42 41.3	110 101.6	15 20
180M 284T	180 177.8	279 279.4	241 241.3	121 121	15 13.5	48 47.6	110 117.5	18.5 25
180L 286T	180 177.8	279 279.4	279 279.4	121 121	15 13.5	48 47.6	110 117.5	22 30
200M 324T	200 203.2	318 317.5	267 266.7	133 133	19 16.7	55 54	110 133.4	30 40
200L 326T	200 203.2	318 317.5	305 304.8	133 133	19 16.7	55 54	110 133.4	37 50



## Frame enclosures

Apart from providing structural support, enclosures protect the motor assembly from the environment. NEMA uses a type number to describe an enclosure whereas IEC uses a two digit 'Index of Protection' (IP) code, also known as 'Ingress Protection'. Shown below are some commonly used NEMA motors with their equivalent IEC code.

- **NEMA Type 2:** Indoor use to provide a degree of protection against a limited amount of falling water and dirt. Meets or exceeds IP11
- **NEMA Type 3:** Intended for outdoor use primarily to provide a degree of protection against rain, sleet, windblown dust, and damage from external ice formation. Meets or exceeds IP54
- **NEMA Type 4:** Intended for indoor or outdoor use primarily to provide a degree of protection against windblown dust and rain, splashing water, hose directed water, and damage from external ice formation. Meets or exceeds IP56

IEC and NEMA have similar definitions. Regulatory agencies, such as the Underwriters Laboratory (UL), are involved in certifying that motors are compatible for these duties. Therefore, it is best to work with the end user and motor manufacturer to clearly define and select the appropriate motor for the application.

## Motor design type

Motors are available with several speed-torque characteristics and should be selected to meet the requirements of the driven load. NEMA lists design A, B, C, and D as typical with B being the most commonly used in industrial applications. IEC uses different nomenclature, for example 'N' is equivalent to the NEMA 'B' design.

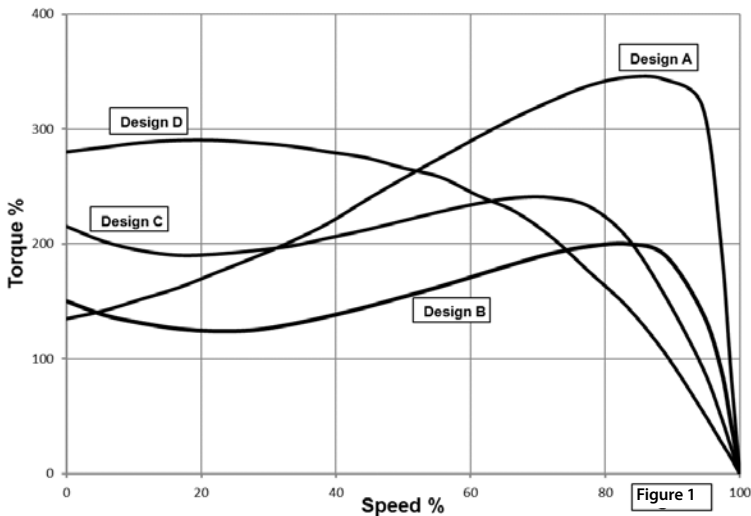

- NEMA A design motors draw a high starting current and associated devices need to be protected accordingly. These motors are used in similar applications as Design B motors.
- NEMA B design motors are suitable for applications such as fans, pumps, compressors, lightly loaded conveyors, and machine tools.
-

- NEMA C design motors are used in applications requiring high starting torques such as reciprocating pumps, heavily loaded conveyors, crushers, and mixers.
- NEMA D design motors are used in hard to start applications such as punch presses, shears, oil well pumps, and elevators.

- Locked Rotor Torque (LTR), also called starting torque, is the torque developed at standstill
- Pull Up Torque (PUT), also called torque, is the minimum torque developed as the motor accelerates from standstill
- Break Down Torque (BDT), also called pull-out torque, is the maximum torque the motor is capable of developing
- Full Load Torque (FLT) is the torque developed to match the load requirements

The torque/speed curve for motors typically looks like those shown in Figure 2. NEMA D design motors are the exception as seen in Figure 1.

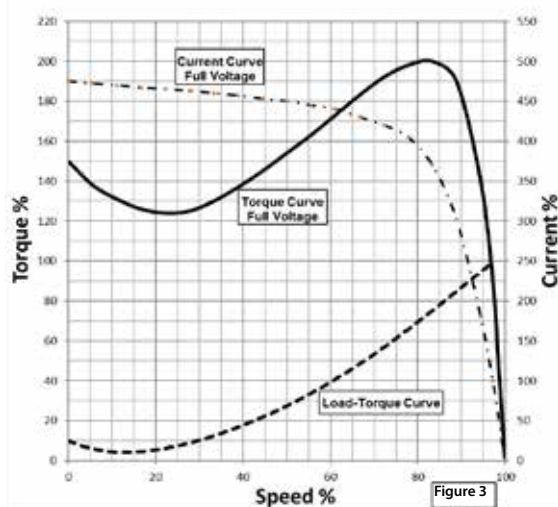
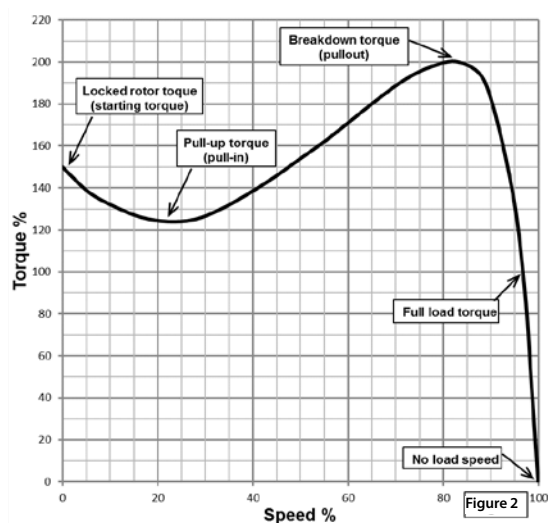

Figure 3 shows motor torque/speed, typical load/speed and current draw/speed curves. Current draw at start-up is high and falls as the motor comes up to speed. As long as the motor torque is greater than the load torque, the motor will accelerate the load to the operating speed. Final motor speed is less than synchronous speed and the difference is known as 'slip'.

## Insulation class

Motor windings are insulated and the class rating is an indication of the thermal tolerance of the insulation. The Class is based on the ambient temperature, temperature rise under load, and the thermal capacity of the insulation. The temperature is determined by adding the ambient temperature to the heat generated by the motor. NEMA and IEC use the same letter designations to describe the Class as follows.

Class	Temperature
A	105 °C [221 °F]
B	130 °C [266 °F]
F	155 °C [311 °F]
H	180 °C [356 °F]

Typically, depending on the application, Class B or Class F insulation is used for industrial duty motors.

## Motor efficiency

In continuous duty applications, the operating costs for a low efficiency motor can be significant. Inefficiency is due to electrical and mechanical losses that are inherent in the design of a motor. Therefore, industry standards encourage manufacturers to build motors that offer higher efficiencies. Whilst these motors may cost more to purchase, in the long term, the added cost may be recovered within a few weeks or months.

## Service Factor

SF (Service Factor) gives the additional power a motor is capable of operating above the rated output. The increased capability is meant for short term service conditions and motors should not be run continuously above the rated output. Operating in overload for extended periods compromises motor life.

Most motors have a SF =1.15 though this will be de-rated to 1.0 when duty conditions demand it; for example, in hazardous duty applications, high elevation installation. Motor manufacturers guidelines should be used during the sizing and application process.

## Mounting

Several mounting arrangements are available such as foot mounted and flange mounted. Configuration selection depends on the type of application the motor is to be installed in.

## Environment

Selection of motors depends on installation locations and the duty conditions. Motors are de-rated when installed at altitudes above 1000 m [3300]. Ambient temperature conditions also affect the output power rating. In such instances, if necessary, larger motors would be selected.

Marine, chemical, petrochemical, gas, dust, and fiber containing environments affect the design of the motors that can be used in such installations. Additional protective measures are required for aggressive conditions.

## Variable Frequency Drives (VFD)

Variable frequency drives are becoming popular because the ability to change the motor speed to meet the duty conditions results in improved process control and reduced power losses as compared to using discharge valve restrictions to set the operating point.

VFD controllers produce distorted voltage and current waveforms that generate parasitic high frequency harmonics which create heat in the motor windings. Additionally, running a motor at reduced speeds cuts down on the cooling air flow over the body and the motor could run at a higher temperature.

Therefore, it is important to select motors that are specifically designed for VFD duty and to ensure that they are suitable for the environment they are to be installed in. Motor manufacturers can assist in the sizing and selection process.

## Formulas

Listed below are some useful equations relevant to the design and selection of motors.

### Synchronous speed and slip.

A motor's speed depends on the input frequency (f) and the number of magnetic poles (p) it has been built with.

$$\text{Synchronous speed (rpm)} = \frac{120 \times f}{p}$$

For example, a 4 pole motor at 60 Hz would have a synchronous speed of 1800 rpm. At 50 Hz the speed would be 1500 rpm.

Operating full load speed (Nr) is less than the synchronous speed (Ns) and the difference between these two is called slip. It is typically given as a percentage.

$$\% \text{ slip} = \frac{100 \times (N_s - N_r)}{N_s}$$

A 5 % slip is typical in most induction motors. Motors, such as NEMA D design, can have slips up to 20 % and are designed for applications where high torque values are needed.

### Horsepower and torque

Horsepower (hp) is the rate of doing work and is a function of torque (T) and speed (N).

$$\text{hp} = \frac{T \times N}{5252} : \text{ where T is in lbs.ft and N is the rpm.}$$

In metric units:

$$P = \frac{T \times N}{9543} \text{ kW} : \text{ where T is in Nm and N is the rpm.}$$

### Electric power

Electric power in a 3-phase system is given by the following equation;

$$P = \sqrt{3} \times \frac{(V \times I \times \text{pf})}{1000} : \text{ where V is voltage, I is the current in amps and } \cos\Phi \text{ is the power factor.}$$

## Examples of drives



*HM pump with reverse overhead mounted motor and v-belt drive.*



*VF pump with vertically mounted motor (shaft up) and v-belt drive.*



*MM pump with direct coupled motor*

## 18. Noise

At certain installations and operating conditions away from the optimum operating point, the noise level may exceed 70 dB(A). Under normal working conditions, the pump's motor is the main source of noise. As a rule of thumb, it may be assumed that the total noise level in the majority of properly functioning installations is that of the motor plus 2 dB(A).

Noise level data can be obtained from motor manufacturers for their product. Other equipment can add to overall noise levels. Personnel should wear appropriate hearing protection devices as mandated by the site and/or applicable regulations.

## 19. Shaft seal options

A horizontal centrifugal slurry pump requires a seal to prevent product leakage into the environment across the shaft/pump case interface or, in suction lift situations, to stop air from entering into the pump. A cantilevered shaft vertical pump with submerged casing does not require any seal.

### Water flush glands

Compression packing was originally developed to provide this barrier and is still used throughout the industry. A clean water flush to promote lubrication and cooling is necessary for the seal to function effectively. Note some of this fluid may leak into the environment.

Product will leak out if there is a loss in flush water, a packing failure, and/or excessive shaft sleeve wear. Apart from losing production, depending on the type of fluid being pumped, environmental damage can occur and personnel safety could be at risk.

Packing requires a consistent maintenance program and will need to be replaced several times during the operating life of the pump. A variety of packing types are available to meet the needs of users for the product being pumped and the service conditions.

#### The following steps will provide successful sealing

- Correct selection of packing material for the application and service
- Gland water pressure must be 0.5 – 1.0 bar (7.3 - 14.5 psi) above discharge pressure of the pump and at recommended flow rates provided in the operating manuals
- Good maintenance is recommended to ensure long service intervals
- Correct installation. Attention to fit and cleanliness is essential
- Sufficient bedding in time and procedures must be followed. Care taken at start-up can significantly extend service life of the packing set



Water flushed glands can either be full flow or low flow, see examples below.

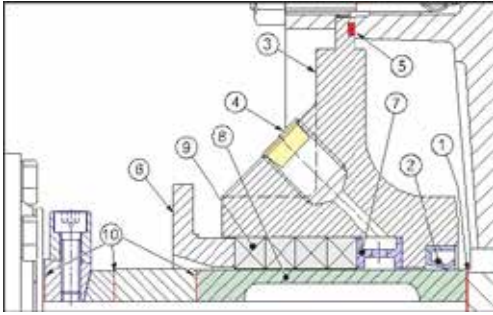

Figure 1: Full flow gland

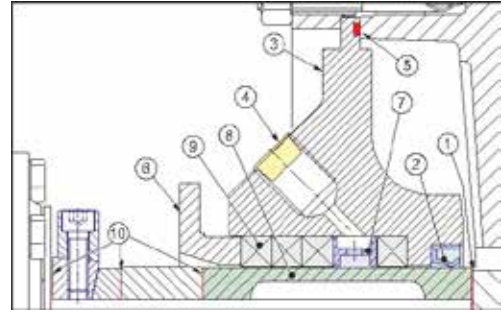

Figure 2: Low flow gland

Table 1: Part No. description	
1. Impeller gasket	6. Gland follower
2. Gland seal (lip-seal)	7. Lantern ring
3. Stuffing box	8. Shaft sleeve
4. Dust plug (water flush port)	9. Packing
5. Stuffing box seal	10. Shaft sleeve seal/gasket

The Metso Outotec EnviroSet™, a sealing solution developed together with A.W.Chesterton, is a packed gland option which can be supplied with new pumps or issued as a kit for retrofitting a low flow or full flow gland on-site. This design uses high quality packing and a unique patented throat bushing specially engineered to control the internal stuffing box environment in a slurry pump.

The SpiralTrac™ throat bushing, (a trademark of EnviroSeal Engineering Products Ltd.), controls the sealing water flow and redirects slurry particles back towards the impeller and into the pump casing. This ability to remove particles from the stuffing box improves packing and shaft sleeve life.

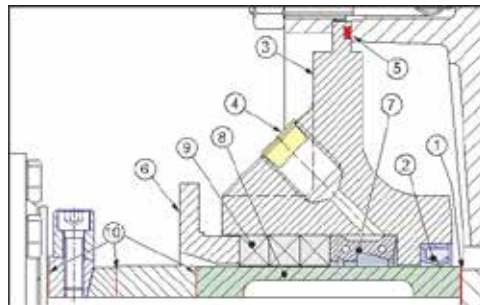

Figure 3: Metso Outotec EnviroSet™ gland

Table 2: Part No. description	
1. Impeller gasket	6. Gland follower
2. Gland seal (lip-seal)	7. Throat bush
3. Stuffing box	8. Shaft sleeve
4. Dust plug (water flush port)	9. Packing
5. Stuffing box seal	10. Shaft sleeve seal/gasket



## Flushed Gland

A pump that has an impeller with pump out (expelling vanes) on the back shroud may seal with no flush water if operated far out on its curve. Running at these duty conditions is not recommended nor usually done.

At lower flow rates, seal water at pressures greater than discharge pressure is necessary to prevent product leakage.

## Centrifugal sealing

A centrifugal (expeller) seal can significantly improve sealing capabilities but as a hydrodynamic device, it is only effective when the pump is running. The main purpose of the packing installed here is to provide a dry seal when the pump is not running and to withstand static pressures. In the majority of applications, centrifugal expeller aided packed glands can offer distinct advantages:

- No sealing water required
- No product dilution
- Zero gland leakage when running
- Reduction in maintenance costs
- Reduced cost when compared to mechanical seals

Selection of the expeller seal must be checked carefully since it is limited to an operating envelope that is controlled by conditions such as:

- Inlet head
- Discharge head
- Expeller/impeller diameter ratio
- Pump speed
- Slurry specific gravity
- Isolating valves in the suction and discharge lines

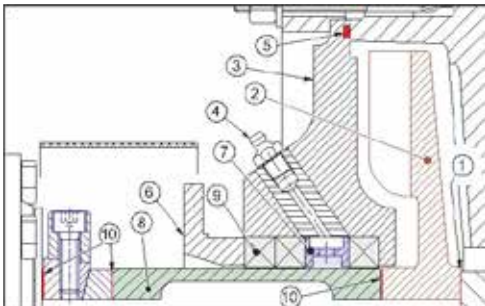

Figure 4: Expeller gland

Table 3: Part No. description	
1. Impeller gasket	6. Gland follower
2. Expeller	7. Lantern ring
3. Expeller ring	8. Shaft sleeve
4. Grease nipple	9. Packing
5. Expeller ring seal	10. Shaft sleeve seal/gasket

The figures below provide a visual explanation of the sealing capability of a typical expeller gland. Metso Outotec's PumpDim program can be used to select an expeller gland and advise the maximum allowable inlet head (sump level).

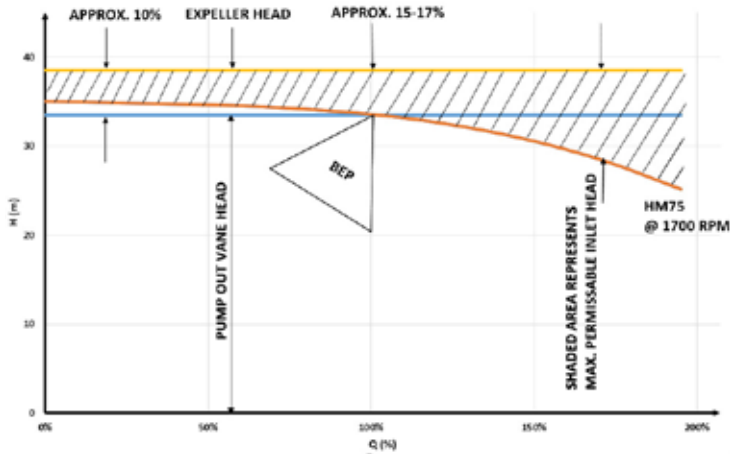

Figure 5

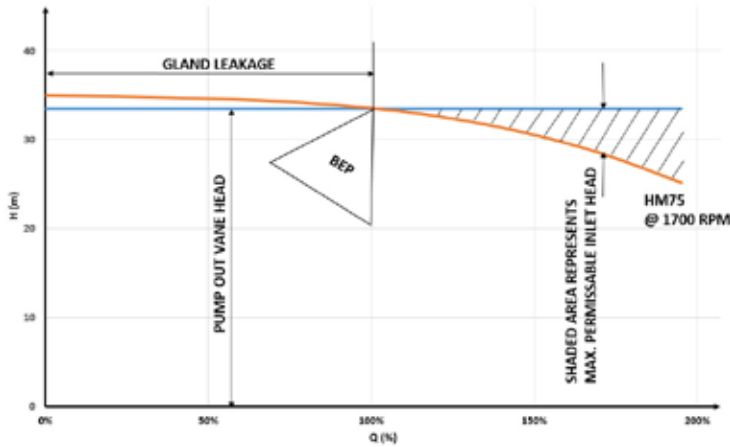

Figure 6

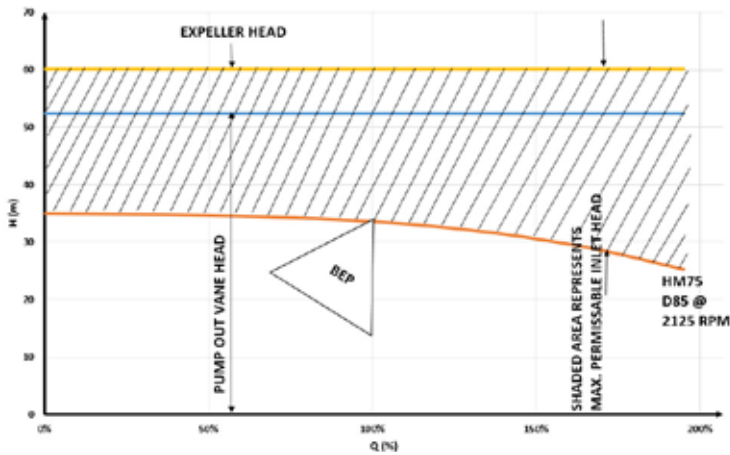

Figure 7

### Expeller gland

The expeller, being positioned behind the main impeller, works as a secondary impeller in series with the impeller pump out vanes.

A dry seal is achieved over the full operating curve because the total pressure generated by the expeller and the pump out vanes is greater than the discharge pressure (sum of pressure produced by the main impeller vanes and the inlet pressure).

A general guideline is that inlet head should not exceed 10 % of discharge head for an effective dry seal.

### Expeller gland with a differential impeller

A high inlet head and/or duty point location can result in a situation where an expeller gland will not seal effectively. Reducing the main impeller vanes (differential) to modify the expeller/impeller diameter ratio and increasing pump speed to operate at the desired duty point results in a significant increase in sealing capability of the expeller system. Metso Outotec has standardized the differential impeller at 85 % of the main impeller diameter.

### Mechanical seals

Nowadays, mechanical seals for slurry pumping are available that offer reliable operation. In some applications, sealing water may not be needed since the product fluid lubricates the sealing faces. The given application will dictate the type of mechanical seal (single or double) and the required support system.

Metso Outotec mechanical seals are designed to allow for axial movement of the impeller. This allows the clearances to be maintained for operational efficiencies. The seals are for slurry applications and are available in several material and coating options.

Depending on the application, Metso Outotec’s slurry seals are offered in the following configurations:

Basic Components of a Mechanical Seal

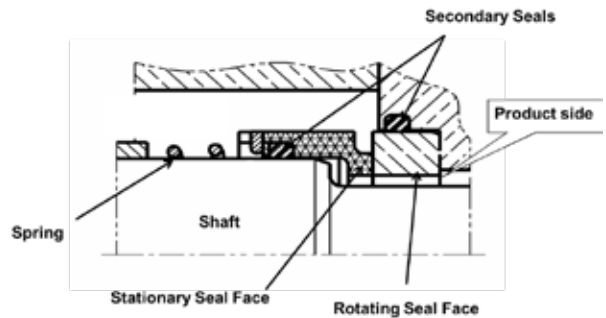

Figure 8: Basic mechanical seal components

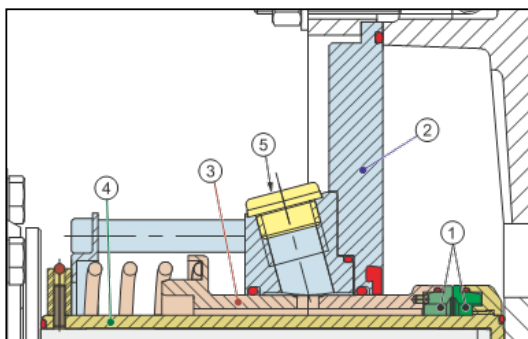

Figure 9: Orion series pump with a Metso Outotec BF-ZF single mechanical seal.

#### Model BF-ZF single mechanical seal – Zero Flush.

- Fluid in slurry lubricates and cools the seal faces
- If necessary can be flushed with a low pressure sealing liquid
- Seal faces can be replaced in the field for ease of maintenance and cost reduction

Table 4: Part No. description

1. Seal faces	4. Rotating seal assembly
2. Integral seal plate	5. Plug
3. Stationary seal assembly	

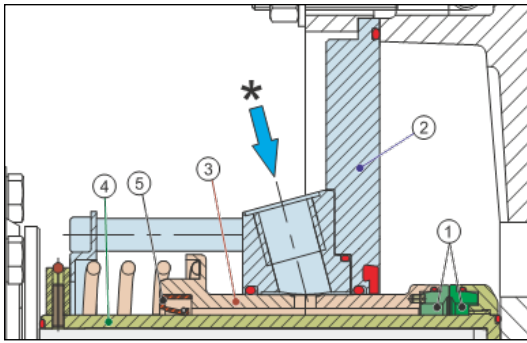

Figure 10: Orion series pump with a Metso Outotec BF single mechanical seal.

Table 5: Part No. description	
1. Seal faces	4. Rotating seal assembly
2. Integral seal plate	5. Quench water lipseal
3. Stationary seal assembly	* Quench water port

**Model BF single mechanical seal – Low pressure flush**

- Lip seal installed on outboard side of stationary ring and shaft sleeve
- Flush fluid at 0.4 bar (6 psi) lubricates and cools seal faces
- Fluid can be ported out to a user approved drain/catchment area or circulated in a closed loop buffer fluid system
- Seal faces can be replaced in the field for ease of maintenance and cost reduction

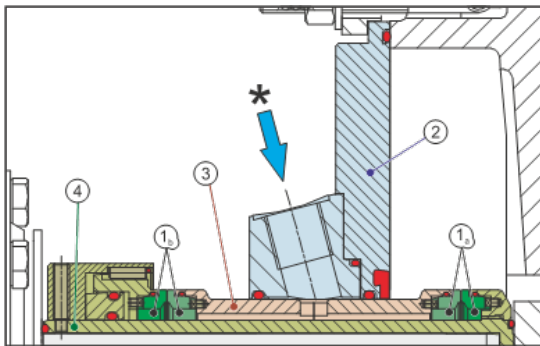

Figure 11: Orion series pump with a Metso Outotec BA double mechanical seal.

Table 6: Part No. description	
1a. Seal faces	4. Rotating seal assembly
2. Integral seal plate	* Quench water port
3. Stationary seal assembly	

**Model BA double mechanical seal – low or high pressure flush**

- Low pressure flush – pressure in seal is lower than in pump
- High pressure flush – pressure in seal is higher than in pump
- Pumping device option available to help circulate barrier fluid
- Buffer fluid system is required
- Seal faces can be replaced in the field for ease of maintenance and cost reduction

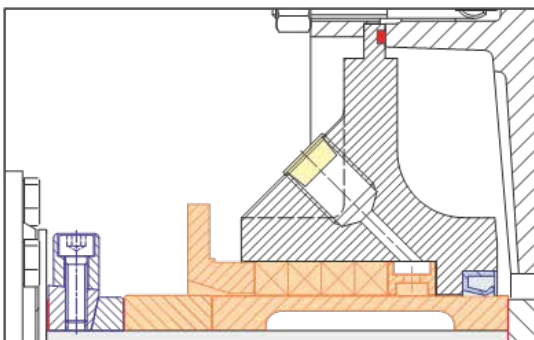

Figure 12: Orion series pump with full flow gland configuration before conversion

**Model ESF cartridge design single mechanical seal**

- Flush gland port to protect seal faces from slurry ingress past lip seal
- Designed to fit into a standard stuffing box on the Orion Series.
- Self-storing centering clips to keep seal faces in position when adjusting impeller/casing clearances
- Cartridge design makes for easy installation
- Seal faces can be replaced in the field for ease of maintenance and cost reduction

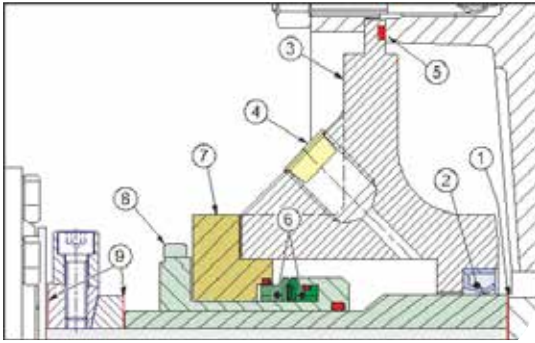

Table 7: Part No. description	
1. Impeller gasket	6. Seal faces
2. Gland seal (lip-seal)	7. Stationary seal assembly
3. Stuffing box	8. Rotating seal assembly
4. Dust plug (water flush port)	9. Shaft sleeve seal/gasket
5. Stuffing box seal	

Figure 13: Orion series pump with ESF single mechanical seal in a standard stuffing box

If in doubt, contact Metso Outotec Proposal Support.

## Sealing type selection guide

Typical applications for Metso Outotec mechanical seals are tabulated below.

Model	Application	Hydraulic Institute Service Class (Slurry Rank)	Metso Outotec's equivalent duty class
BF Single Mechanical Seal	<ul style="list-style-type: none"> <li>• Mine dewatering</li> <li>• Waste water handling</li> <li>• Mildly abrasive industrial minerals</li> </ul>	1 (Light)	Mildly abrasive
BA Double Mechanical Seal	<ul style="list-style-type: none"> <li>• Small abrasive particles (1-5 microns)</li> <li>• High pressure and/or high temperature</li> <li>• General mineral processing</li> <li>• Abrasive industrial minerals</li> <li>• Coating products – Pulp and Paper</li> <li>• Hazardous liquids</li> <li>• Applications requiring double seals to prevent leakage to the environment.</li> </ul>	1-2 (Light – Medium)	Mildly abrasive to Abrasive
ESF Cartridge Mechanical Seal	<ul style="list-style-type: none"> <li>• Filter feed.</li> <li>• Cyclone feed</li> <li>• Mill discharge</li> </ul>	1-4 (Light – Very Heavy)	Mildly abrasive to Extremely abrasive

Table 8: Seal type selection based on the Hydraulic Institute service class

Metso Outotec slurry seals have seal faces in carbide materials. The BA and BF seal faces are in Silicon Carbide. The ESF seal has Tungsten Carbide seal faces.

To perform well, the seals must have access to clean sealing liquid. There has to be liquid at the seal to lubricate and cool the faces at all times during operation, otherwise the seals can be destroyed within seconds.

Depending on the application, the pressure in the sealing liquid may be either higher or lower than the pressure in the pump. On applications where the pump is continuously operated on a positive inlet pressure, and in a light slurry application, a non-flushed version of the BF seal may be acceptable.

The table below can assist in selecting a seal and buffer system for typical applications.

Application Characteristics	Examples	Type of Seal	Type of Buffer Fluid System
Small Abrasive particles - critical size of 1-5 microns	All metals: Fe, Co, Ni, Mo, Cu, Zn, etc Salts Kaolin - China Clay	Double seal Type BA-H3	High Pressure Buffer Fluid
Fibrous Slurries	Latex Glue	Double seal Type BA-H3	High Pressure Buffer Fluid
Slurries with low water content	Some sewages Organic waste	Double seal Type BA-H3	High Pressure Buffer Fluid
Slurries with tendency to form coatings/layers	Lime Cement	Double seal Type BA-H3	High Pressure Buffer Fluid
Slurries Hazardous to human health	Acidic slurry Caustic liquors	Double seal Type BA-H3	High Pressure Buffer Fluid
Risk of dry running (potential of negative pressure at pump inlet)	Depending on pump inlet conditions, piping solutions & sump level	Double seal Type BA-H3	High Pressure Buffer Fluid Low pressure Buffer Fluid
Risk for running against closed valves during longer periods of time	Filter feed and similar	Double seal Type BA-H3	High Pressure Buffer Fluid Low pressure Buffer Fluid
Light slurry applications with: Low concentration of solids Negligible amount of critical size particles (1-5 microns) Slurry not hazardous to human health		Single seal Type BF-H3- Zero Flush	None
Light slurry applications with: Risk for dry running Fibrous products Products forming coatings / layers		Single seal Type BF-H3 with lip seal	Low pressure Buffer Fluid
Mildly abrasive to extremely abrasive	Filter feed. Cyclone feed. Mill discharge.	ESF	Pressurized front flushing

Table 9: Seal type and buffer system based on typical applications

## Buffer fluid systems

To avoid failure, the sealing faces in a mechanical seal must be lubricated and kept cool. In some light slurry applications, a zero-flush single mechanical seal may work well as long as the pumped product can meet the requirements in tables 8 and 9. In all other applications the mechanical seal will require some form of sealing water system.

The sketches below show some types of buffer fluid systems that are available. Buffer fluid flow and pressure requirements are given in Instructions and Operating manuals.

### High pressure flush

Double seals, type BA.

1. Flow controller
2. Pressure gauge
5. Quench water return
6. Quench water input

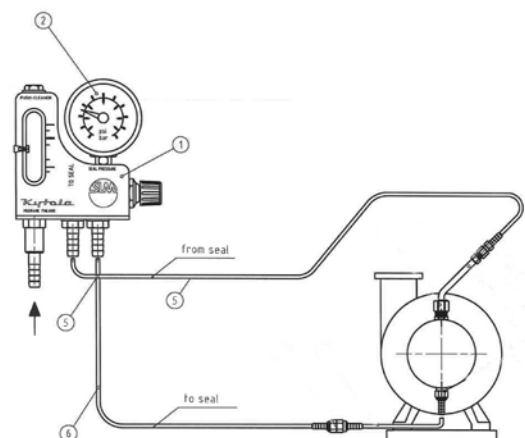

Figure 14: Example of a high pressure flush system

This system keeps the primary seal operating on clean water and protects the secondary seal from dry running. It also cools the seal effectively and prevents any reactions between the pumped product and air. There will always be a flow to drain and adequate system flow has to be maintained.

### High pressure flush - dead ended

Double seals, type BA

Same behavior as previously described but with no drain flow to waste. Applicable for situations where water consumption is not acceptable.

1. Flow controller
2. Pressure gauge
4. Quench water pipework
6. Stopcock (shut-off valve)

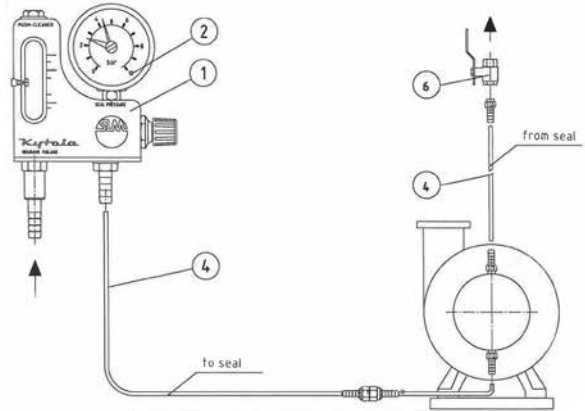

Figure 15: Example of a high pressure flush - dead ended system

### Low pressure flush

Single seals, type BF

Seal pressure is lower than the product pressure at the seal face. Primary seal depends on the pumped product for lubrication. The buffering water acts as a coolant and cleansing agent for the primary seal and protects the secondary seal from running dry. There will always be a flow to drain and adequate system flow has to be maintained.

1. Flow controller
2. Quench water pipework

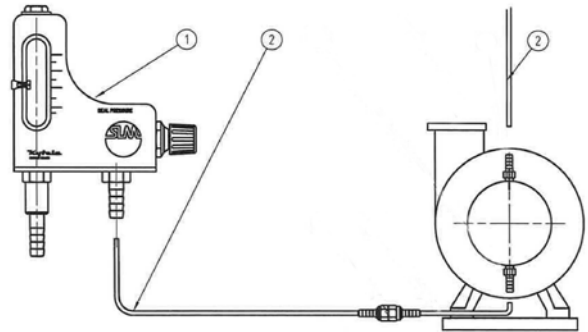

Figure 16: Example of a low pressure flush system

### Thermosiphon systems

Item	Description
10	Thermosiphon tank
20	Pressure gauge
30	Temperature gauge
40	Mechanical seal

The single seal, type BF, and double seal, type BA, may be combined with a special thermosiphon system that circulates liquid due to the temperature difference of the sealing liquid inside the seal and in the tank, thus providing lubrication and cooling for the seal faces. A pump ring can be installed inside the seal to further increase the cooling effects.

The pump operating pressure, slurry being pumped, barrier fluid compatibility, and seal type will dictate the system requirements.

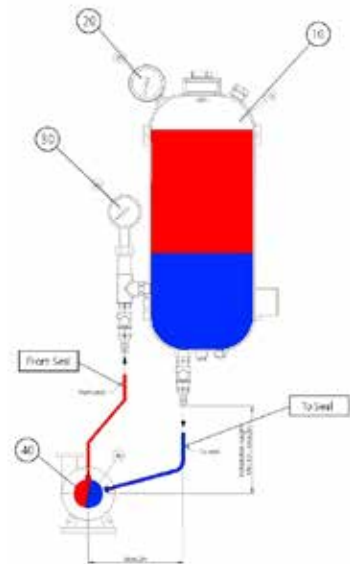

Figure 17: Example of a thermosiphon system

Contact Metso Outotec Proposal Support to select the correct shaft seal and support system for your application.

# 20. Torque – Speed curves

## Minimum flow rates for centrifugal pumps

According to the Affinity Laws:  $BHP \propto N^3$ ; where BHP = power and N = Speed

Also,  $BHP \propto T \times N$ ; where T = torque.

Rearranging the two terms shows that  $T \propto N^2$ .

The torque-speed curve for a centrifugal pump could be drawn in a parabolic shape starting at zero until it reaches its full load torque. In reality, at zero flow, torque is required to overcome inherent friction losses in the equipment and the actual torque speed curve would not start at zero.

In slurry pumping, the inlet and outlet valves should be fully open before a pump is started. Never run the pump with inlet and outlet valves closed. Refer to Operation and Instructions Manuals for specific start-up procedures. Contact Metso Outotec Customer Service for support if needed.

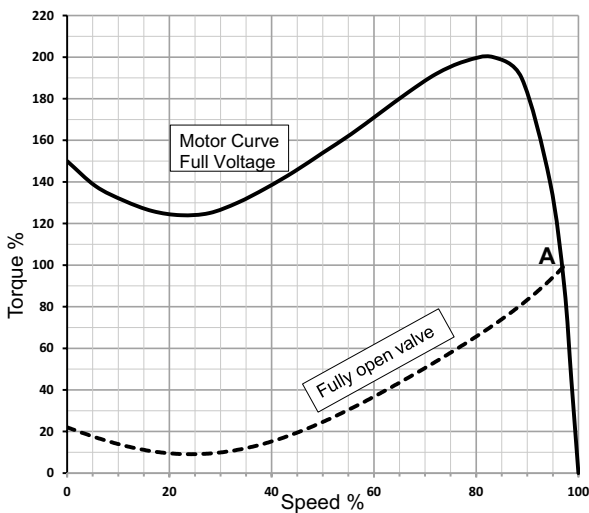

Figure 1

Figure 1 shows the torque-speed curve for a typical Design B electric motor. Intersection point A of the torque-speed curves represents the operating speed of the pump.

The difference in values between the motor torque and the pump torque is the accelerating torque available to overcome the inertia of the rotating elements and to bring the equipment up to operating speed.

A motor started Direct On Line under full voltage draws a very high starting current; see Figure 2. This can, particularly on large motors, be detrimental to the motors integrity as well as result in financial penalties being levied by electric utility companies.

Alternative start-up methods can be used to minimize this demand load. For example, with a Star-Delta winding, start-up in a Star configuration draws low current and then near full-load speed a switchover to Delta can take place (B-B). Other methods such as Autotransformers and VFD's can be used for start-up purposes.

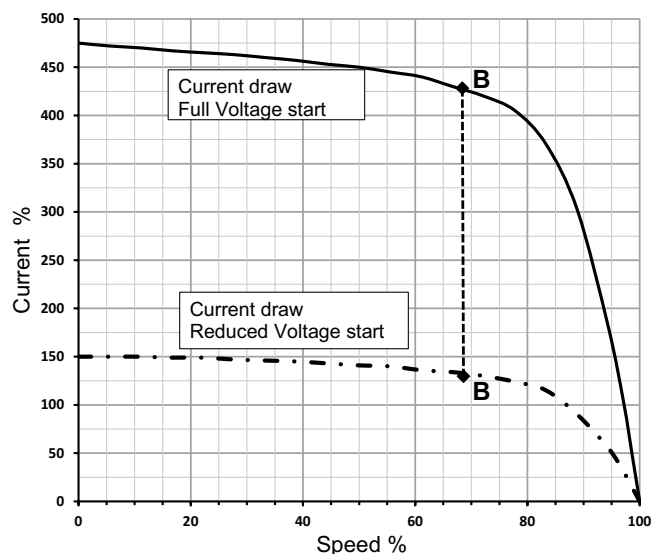
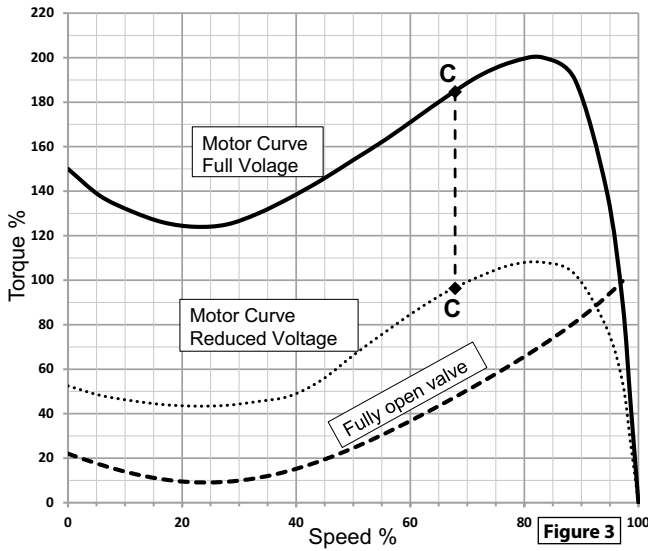

Figure 2





Reducing current draw at start-up also lowers the motor torque and it is important to ensure that the accelerating torque needed for the rotating elements is not compromised, see Figure 3. Switching over to full voltage (C-C) will provide the full motor torque needed at the duty point at the final operating speed.

### Minimum Flow Rates for Centrifugal Pumps

It is important not to run a pump with a closed discharge valve or under low-flow conditions below its rated limit. All the power drawn goes into heating the slurry in the pump casing and can damage equipment as well as pose a safety hazard.

Operating a pump away from the manufacturer’s recommended range can affect mechanical integrity of the components because of increased forces due to axial and radial thrust loads. Even though slurry pumps are robustly designed, this is another reason to not run a pump at low flow rates.

The following equations can be used to calculate the temperature rise in a pump.

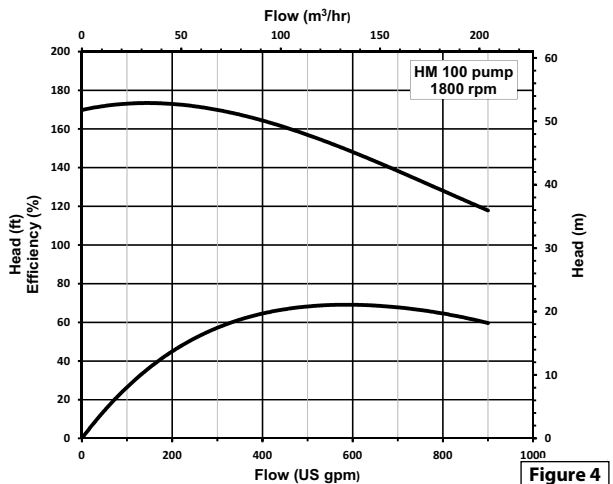

$$\Delta T = \frac{H}{778C_p} \left( \frac{1-\eta}{\eta} \right) ^\circ F$$

$$\Delta T = \frac{gH}{C_p} \left( \frac{1-\eta}{\eta} \right) ^\circ C$$

- |       |                |   |                                                           |
|-------|----------------|---|-----------------------------------------------------------|
| where | H              | = | TDH at operating flow rate (ft)                           |
|       | C <sub>p</sub> | = | Specific heat of the fluid (BTU/lb °F)                    |
|       | η              | = | Pump efficiency (numerical value) at operating flow rate. |
|       | H              | = | TDH at operating flow rate (m)                            |
|       | C <sub>p</sub> | = | Specific heat of the fluid (J/kgK)                        |
|       | η              | = | Pump efficiency (numerical value) at operating flow rate. |
|       | g              | = | Gravitational constant (m/s <sup>2</sup> )                |

The following example demonstrates a temperature rise calculation at various flow rates.

Figure 4 shows Head/Flow and Efficiency/Flow curves for a Metso Outotec HM100 metal pump running at 1800 r/min on water ( $C_p = 1$ ).

Table 1: Temperature rise at reducing flow rates						
Q (US gpm)	H (ft)	$\eta$ (%)	$\Delta T$ (°F)	Q (m <sup>3</sup> /hr)	H (m)	$\Delta T$ (°C)
200	173	45	0.3	45.4	52.7	-17.6
100	173	26	0.6	22.7	52.7	17.4
25	171	8	3	5.7	52.1	-16.1
10	170	3	7	2.3	51.8	-13.9
5	170	1.6	14	1.1	51.8	-10.0
2	170	0.7	33	0.5	51.8	0.6
1	170	0.4	62	0.2	51.8	16.7
0.5	170	0.2	112	0.1	51.8	44.4
0.25	170	0.1	185	0.05	51.8	85.0

Figure 5 is the  $\Delta T/Q$  plot from the data in table 1 and shows that operating at very low flow rates results in high temperature rise. Adding  $\Delta T$  to the inlet fluid temperature gives the discharge temperature value.

The time to reach these temperatures also depends on the amount of slurry that is contained in the pump casing. In addition, the insulating nature of an elastomer lined pump could cause the temperature to rise rapidly.

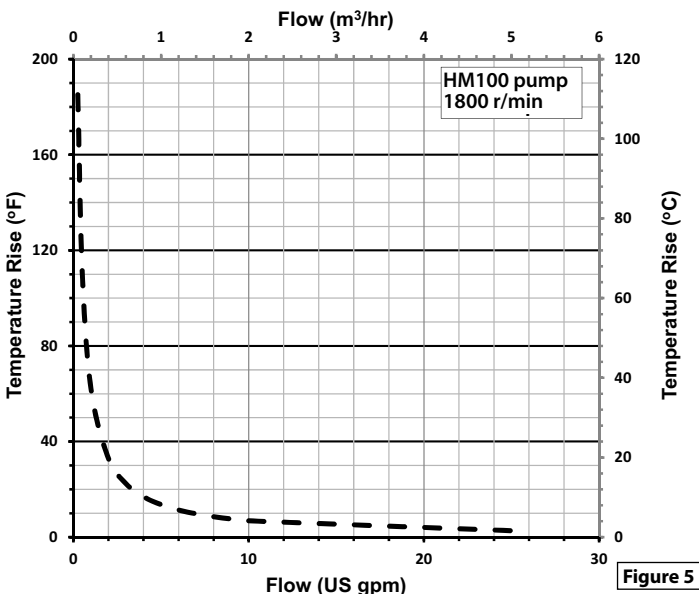

## 21. Vibration

Rotors, such as pump impellers, are typically balanced, statically or dynamically, according to guidelines given in industry standards. Manufacturers may also use criteria based on the design and operating knowledge of their equipment. Balancing is done to minimize shaft deflections and vibration levels in the rotating assemblies so as to prevent damaging pump components and related equipment.

Impellers in clear liquid applications usually remain in a balanced condition during their service life. They are balanced to tighter grade levels as compared to impellers used in slurry pumping applications as these deteriorate by constant use or exposure to the pumped media. Therefore, slurry pump bearing assemblies are designed to be robust so as to withstand out-of-balance forces that can occur throughout the pumps service life.

Vertical slurry pumps with cantilever shafts may, depending on the duty conditions and pump size selection, possibly run at or near the critical speed. This is an unacceptable mode of operation because of the excessive vibrations that will occur and lead to damage of the installed equipment. It is important to verify that this condition will not arise and Metso Outotec Proposal Support can assist in analyzing and selecting the correct configurations.

Hydraulic Institute Standard 12.1-12.6 "Rotodynamic (Centrifugal) Slurry Pumps" states: 'As a rule of thumb, slurry pump impeller balance requirements will fall between grade G40 on the high (large amount of residual imbalance) side and grade G6.3 on the low (small amount of residual imbalance) side as defined in ISO1940/1 'Mechanical Vibration- Balance quality requirements for rotors in constant (rigid) state'.

Metso Outotec follows a procedure that has been developed using the guidelines given in the above referenced standards as well as the design and performance knowledge the company has of its products.

Metso Outotec does 1-plane balancing (static balancing) of all slurry pump metal impellers and cast iron skeletons for elastomer impellers to Grade G16 according to SS-ISO 1940/1.

As per SS-IS 1940/1, pump impellers should be balanced to Grade G6.3. However, this guideline applies to clean liquid pumps where impellers are expected to have an infinite life, and shafts are often slim and have a shaft flexibility factor (SFF) of 1 - 5.

Metso Outotec dredge and slurry pump have an SFF factor of 0.2 - 0.75 and are designed to handle heavy slurries, which can impose high radial loads and the large unbalanced forces that can occur due to uneven wear caused by abrasion and corrosion of the impellers. Therefore, due to the robust design, the dredge and slurry pump impellers are generally balanced to Grade G16.

Metso Outotec can offer balancing to Grade 6.3 as an optional extra. Contact Metso Outotec Proposal Support for recommendations on when the tighter balance grade is applicable.

Balancing is typically done by mounting the impeller on a commercial balancing machine. The part is rotated at the end of the test cycle and the amount of material that needs to be removed is displayed. Material is removed from the heavy side through machining processes until the part is balanced to specification. Metal impellers usually have an arc of material machined off the outside diameter, see Figure 1.

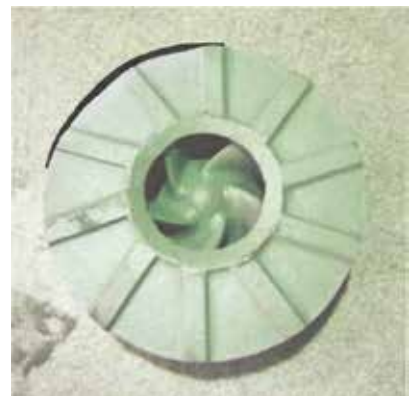

Figure 1



An overall vibration signal is the sum of the frequency spectrum inputs. At times, it may be necessary to break down the signal into its discrete frequency components in order to determine the major contributors to the vibration level. Frequency analyzing equipment is used to assist in diagnosing and identifying the cause of any problematic vibration inputs. Instrumentation should be selected to measure the required frequency range and provide reliable error free read out values.

Measurements are usually taken in the horizontal, vertical, and axial directions on the external surface of the bearing housing where the bearings are located.

Instrumentation should be calibrated and suitable for monitoring vibrations and give output in [mm/s]. Placement of measuring probe should be done in three different directions (x,y,z) at the wet end bearing side. Therefore, it is important to be aware of this when comparing to pumps by other manufacturers.

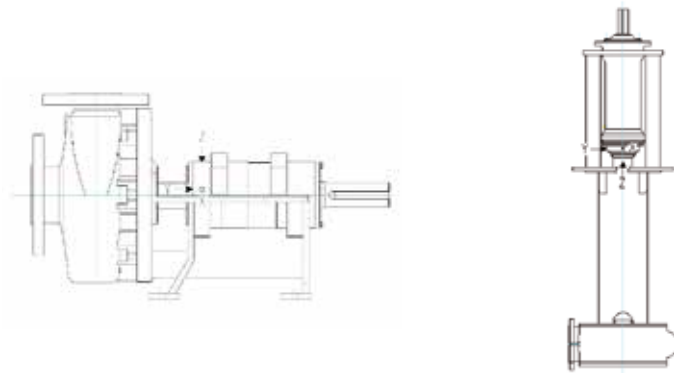

Transducers can be permanently mounted, temporarily installed using a magnetic/adhesive base mount or, as is commonly done, be of the portable hand held design.

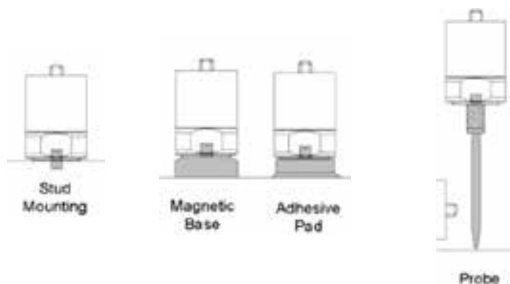

## Vibration Levels

Pumps perform optimally when operated at their Best Efficiency Point (BEP). However, not all applications meet this condition and the duty point will be somewhere along the H/Q curve. A Preferred Operating Range (POR) is often identified and represents a working area which will provide long-term service. An Allowable Operating Range (AOR) is a greater area in which the pump operation may be acceptable but reduced service life is a possibility.

The sketch below shows the variation in vibration levels that can be expected when a pump operates at different points along its performance curve. Running beyond AOR is not recommended. Contact Metso Outotec Proposal Support if such situations will occur.

## Vibration levels for Metso Outotec pumps

Metso Outotec pumps are classified into two groups and ISO10816-1/1995/Amendment 1:2009 is used as a guide to recommend vibration levels as shown below.

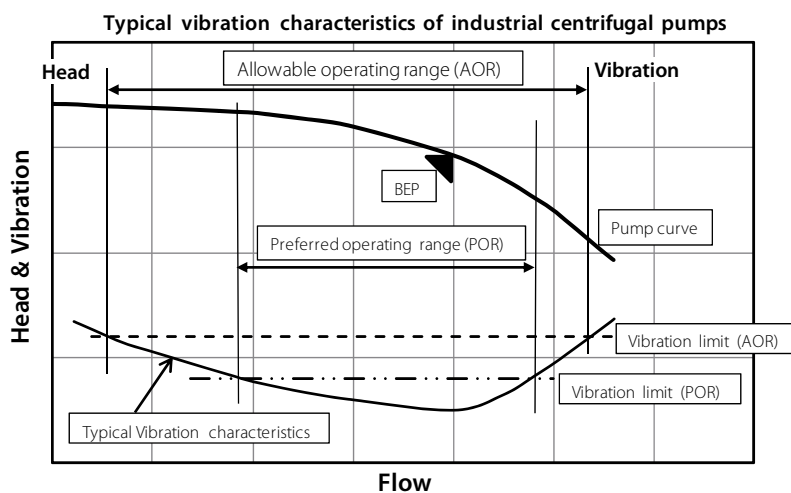

	Vibration level at Inboard Bearings: mm/s (in/s) RMS	
	Group 1	Group 2
	· Horizontal pumps fixed to foundation	· Vertical pumps · Horizontal pumps not fixed to foundation e.g. slide base, vessel installations
New pump, fixed to foundation	2.8 (0.11)	4.5 (0.18)
Pump in long-term operation	4.5 (0.18)	7.1 (0.28)
Limited operation	7.1 (0.28)	9.3 (0.37)
Stop operation immediately	9.3 (0.37)	11.0 (0.43)

## Performance tracking

Most operations systems have a maintenance plan for tracking pump performance and can include vibration level measurements as one of the parameters to record.

Recommended practice is to record vibration levels in the as-new installed condition to establish baseline data and then to track performance at scheduled intervals. Any increase in vibration levels is an indication that preventative maintenance action will be required.

Installing instrumentation that can provide alarm and trip signals is another way to shut-down equipment before damaging conditions occur.

# 22. Viscosity

A variety of techniques can be used to determine the viscous properties of fluids

## Rotational viscometers

A common and economical method for measuring the viscosity of fluids is to use a rotational viscometer, see Figure 1 and Image 1 below.

The viscometer measures the torque required to rotate an immersed element (the spindle) in a fluid. The spindle is driven by a motor through a calibrated spring; deflection of the spring is indicated by a pointer and dial (or a digital display). By utilizing a multiple speed transmission and interchangeable spindles, a variety of viscosity ranges can be measured.

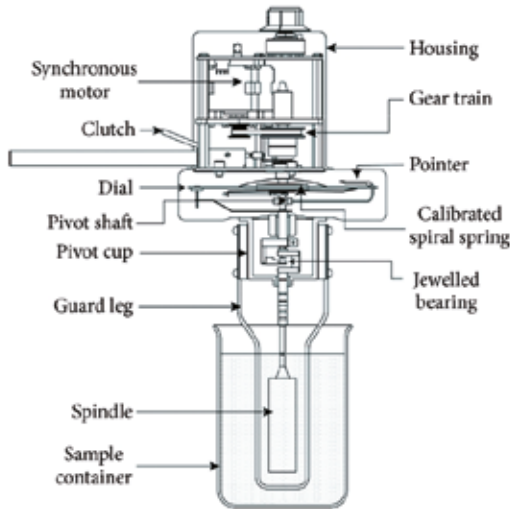

Figure 1



**Image 1: Rotational viscometer and spindle set:**

Courtesy of Brookfield Engineering Laboratories Inc

For a given viscosity, the viscous drag or resistance to flow is proportional to the spindle's speed of rotation and is related to the spindle's size and shape. Measurements made using the same spindle at different speeds are used to detect and evaluate rheological properties of the test fluid.

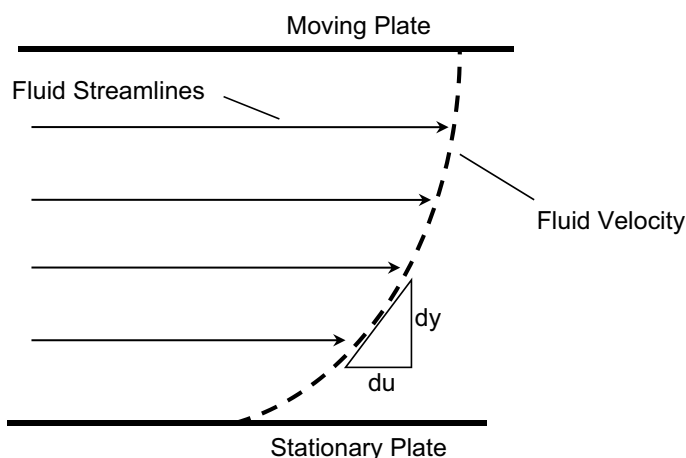

The fluid viscosity can be calculated from the spindle geometry, the spindle/container gap, and the rotational speed using the following definitions and equations.

*Shear stress* ( $\tau$ ) = Force/Area

*Shear rate* ( $\dot{\gamma}$ ) =  $du/dy$

*Viscosity* ( $\mu$ ) = (Shear stress)/(Shear rate)

or,  $\tau = \mu \cdot \dot{\gamma}$

### Tube/pipe viscometers

Reliable results may not be obtained when mineral slurries are tested with rotational type viscometers. Errors in viscosity measurements can have significant effect on the selection and performance of equipment in real situations. To alleviate such problems, tests can be carried out by building large scale piping circuits for determining fluid properties. Alternatively, economical testing can be carried out using small diameter pipe loops to determine viscous properties and the data scaled up to larger piping systems.

Figure 2 below shows a tube type test set-up. The slurry is pumped from Tank 'A' through a tube (pipe) into a Tank 'B'. Different diameter tubes of appropriate varying lengths can be installed to ensure that stable and laminar

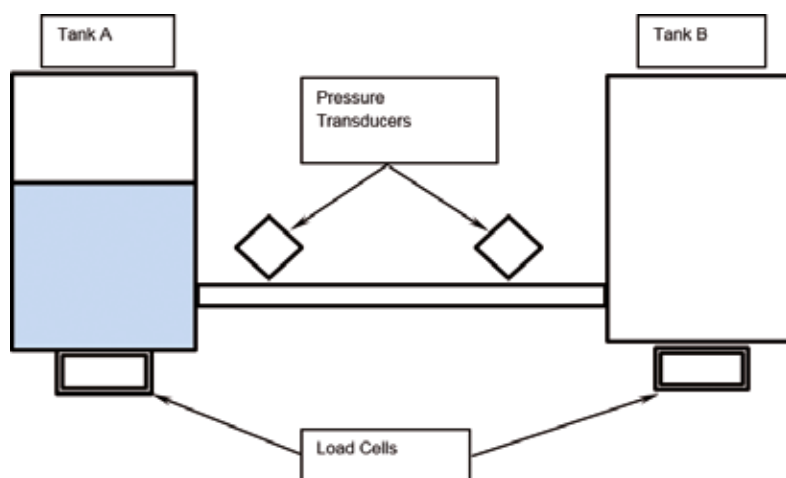

Figure 2

flow regimes are present during testing. The mass change of Tank 'B' over a given time can be used to determine the flow rate through the tube which then allows the shear rate to be calculated. Pressure drop values are used to calculate the shear stress in the fluid.

Fluids can have different rheological properties. A plot of the of Shear Stress versus Shear Rate, as shown in the Figure 3, helps in defining the fluid characteristics.



The slope of the curve, at a given shear rate, is the fluid's Plastic or Tangent viscosity ( $\mu$ ), as shown in Figure 4. This term is also known as the 'coefficient of rigidity' (may also be identified as  $\eta$ ).

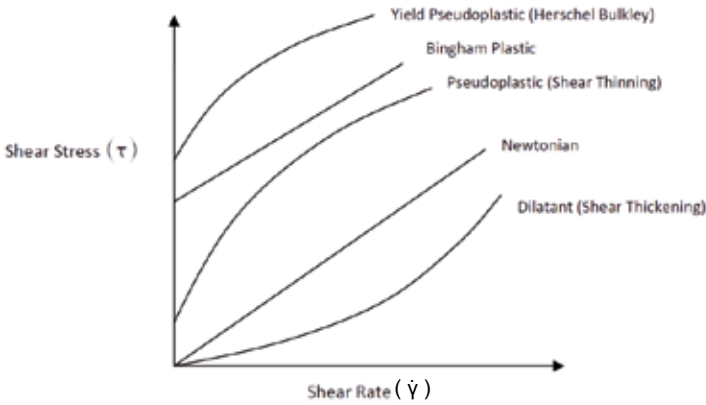

Figure 3

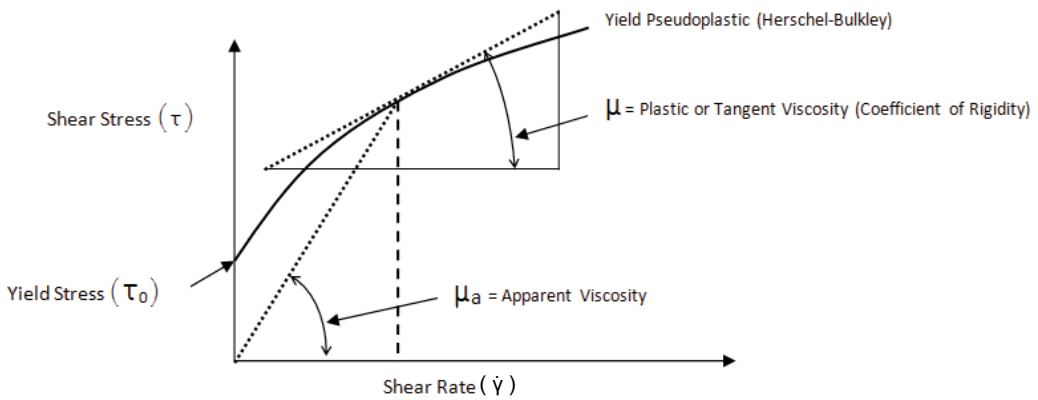

Figure 4

Apparent viscosity ( $\mu_a$ ) assumes that the fluid is Newtonian and is calculated using the shear stress at a given shear rate. For fluids with non-linear properties, the apparent viscosity will have an infinite number of values. Viscosity measurements should be taken at several shear rates in order to fully determine the fluid characteristics and to avoid system sizing calculation errors.

A fluid mixture with a concentration consisting mostly of 40 microns (325 Mesh) or finer particles is called a non-settling slurry.

It is common to refer to solids concentration by weight rather than by volume. However, in pumping non-settling slurries it is important to know concentrations by volume because this value aids in determining the fluid's viscous behavior.

Non-settling slurries typically exhibit Bingham Plastic or Yield Pseudoplastic (Herschel- Bulkley) characteristics.

The equation for Herschel-Bulkley fluids can be expressed as:

$$\tau = \tau_0 + k \cdot \dot{\gamma}^n \quad \text{where } K \text{ and } n \text{ are constants.}$$

A Bingham Plastic with its linear slope can be defined by the following equation:

$$\tau = \tau_y + \mu_p \cdot \dot{\gamma}$$

A Newtonian fluid would be defined as:

$$\tau = \mu \cdot \dot{\gamma}$$

Engineers use, in conjunction with analytical and experimental data, the particle sizes ( $d_{50}$ ,  $d_{80}$ ), and concentration, viscosity ( $\mu$ ), yield stress ( $\tau$ ), and apparent viscosity ( $\mu_a$ ) values to calculate correction factors for the pump and the piping circuit for sizing purposes.

## Pump and system calculations

It is necessary to know the friction losses in a piping system so as to correctly size the circuit. Minimizing these losses will result in low energy consumption and efficient operation.

A viscosity value is needed to calculate the Reynolds Number ( $R_e$ ), a dimensionless term, and a critical parameter required for determining friction losses in the piping system.

$$R_e = \frac{\rho \cdot D \cdot V}{\mu} \quad \text{where } \rho = \text{density, } D = \text{pipe diameter, } V = \text{flow velocity, } \mu = \text{viscosity}$$

Pipe sizing can be designed for laminar ( $R_e \leq 2000$ ), transitional or turbulent flow ( $R_e \geq 3000$ ) through the system.

Laminar flow, as long as particles do not settle, gives the lowest friction losses. If settling is a concern then the next step is to have a flow rate that is just above the critical settling velocity and is in a turbulent flow regime with the lowest possible friction losses. Transitional flow regions are generally not preferred because flow regimes can be unstable.

As an example,  $R_e$  enables a friction factor to be determined from a chart (Moody diagram) which includes surface roughness effects for different pipe types. This factor can then be used in equations such as Darcy-Weisbach to calculate the friction losses in a piping system.

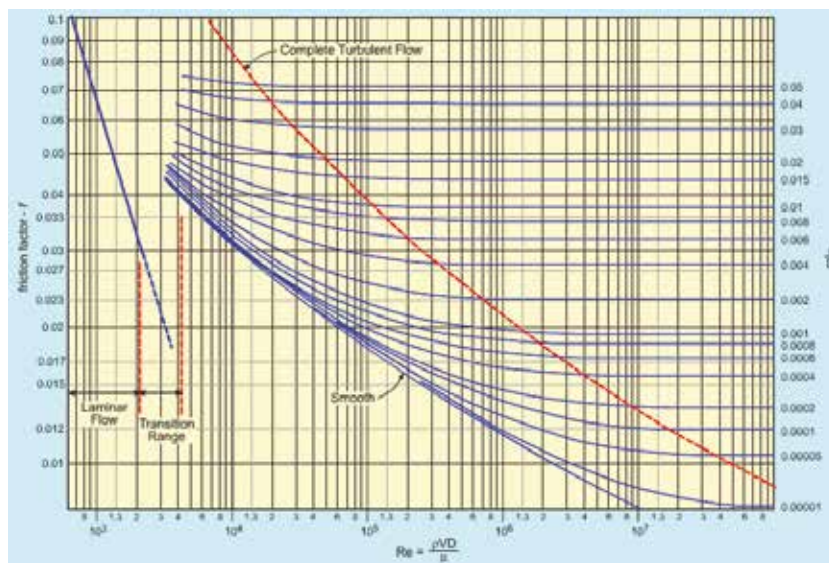

Figure 5

The Darcy-Weisbach equation is as follows:

$$H_L = \frac{f \times L \times V^2}{2 \times g \times D}$$

where:  $H_L$  = head loss in piping  
 $f$  = friction factor  
 $L$  = pipe length  
 $V$  = flow velocity in pipe  
 $g$  = gravitational constant  
 $D$  = pipe diameter

Head loss calculations for Newtonian fluids can be done using this equation. However, head loss calculations for non-settling viscous slurries exhibiting non-Newtonian characteristics do not give reliable results. More sophisticated techniques are used in these situations.

Experience has shown that pumping non-Newtonian fluids at flow rates considerably lower than at BEP can result in an unstable H/Q curve and the pump does not operate as expected.

Figure 6 shows how the pump and system can behave when handling a viscous non-settling slurry with a high yield stress. Therefore, it is important to clearly understand a fluid's viscosity characteristics.

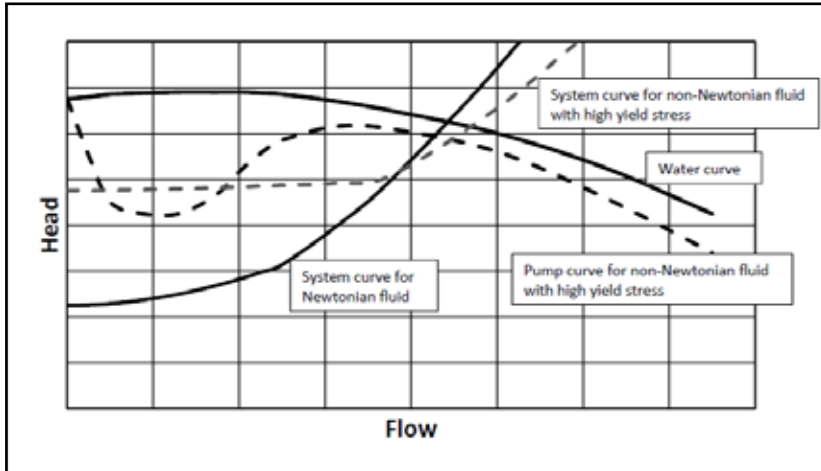

Figure 6

The Reynold number can also be calculated to determine the head ( $H_r$ ) and efficiency ( $E_r$ ) correction factors for the pump.

The Efficiency ( $E_r$ ) correction for viscous slurries can be significant and have a major impact on power requirements.

Net Positive Suction Head Requirements ( $NPSH_r$ ) will be higher for viscous and non-settling slurries than the published curves which are based on water.

Hydraulic Institute Standard ANSI/HI 12.1-12.6-2005 "Rotodynamic (Centrifugal) Slurry Pumps" recommends that 'the pump manufacturer should be consulted for guidance regarding non-Newtonian effects on pump performance'.













Metso Outotec's PumpTM program makes use of proprietary information as well as the above calculation techniques for sizing purposes. Users should contact Metso Outotec Proposal Support when handling non-settling slurries.

## Can a slurry mixture be pumped?

A preliminary evaluation using the following simple methods can aid in determining if a slurry mixture can be pumped.

### Slump test

A short length of pipe is placed upright the center of a series of equally spaced concentric rings scribed on a flat surface (can be a board or metal plate). The pipe is filled with the test slurry and then lifted completely straight up to allow the slurry to slump out onto the surface. The extent to which the slurry spreads out provides a visual indication of the ability to pump a particular concentration as shown in following Example 1.

Concentration by weight	Coarse Solids	Fine Solids
75 %		
70 %		
65 %		
60 %		
50 %		
40 %		

Example 1: Slump test with fine and coarse solids.

## Pencil test

If only a small sample of the slurry is available, then the following test can give an indication of whether or not the fluid is pumpable.

The slurry sample is poured into a beaker and a wooden pencil stuck vertically in the center of the mixture. If the pencil falls over to the side of the beaker then it should be possible to pump the slurry. If the pencil stays upright then the material cannot be pumped. See Example 2.



Example 2: Pencil test.

## 23. Types of wear

Properties of the carrier fluid, the solids in the slurry, and the materials of construction all affect the wear life of the wet-end components in a slurry pump.

Carrier fluid rheology, chemical characteristics (pH), fluid temperature, and the flow patterns within the pump affect the wear and corrosion behavior of the components.

The mass of the solids carried by the fluid multiplied by the velocity squared gives the energy with which the particles can impact a surface. The energy level combined with particle characteristics of size, hardness, shape (sharp, angular, or rounded), and concentration determine the type of wear that will occur.

Metal microstructure, hardness, corrosion resistance, and part shape have an influence on part life in abrasive duties.

Elastomer part life is affected by hardness, tear strength, chemical compatibility, and temperature limits of the material.

Furthermore, the inlet flow conditions (NPSH<sub>A</sub>) and the operating duty point on the performance curve affect flow patterns within the pump and influence component wear life. The type of duty the equipment is installed in (mill discharge, tailings etc.) also affects wear and part life.

### Types of wear

Abrasive, erosive, and chemical wear occurs in solids handling pumps. See Chapter 6, Wear protection.

### Design of parts

Wet-end components have to be designed to withstand wear caused by the slurry being pumped. Engineers consider several criteria when designing the pumps, for example:

- Offering a range of pumps so that selections can be made for operating conditions to be close to the Best Efficiency Point (BEP) for optimum performance. Low inlet velocities result in smoother fluid flow as well as minimize impact damage from solids
- Offering pumps to match duty conditions that can range from mildly to extremely abrasive. In addition to offering material options, Metso Outotec uses Impeller Aspect Ratio (IAR) criteria to optimize the selection
- Thick sections in known wear areas, such as the impeller back shroud, impeller vanes, and volute cut-water point
- Providing means of adjusting the impeller running clearances to reduce wear and maintain performance  
A pump with a double adjustment feature enables this to be done

#### Other factors taken into consideration are:

- Minimizing shaft deflection by having a short impeller overhang
- Ease of impeller removal using an impeller release mechanism
- Sealing options: full water flush, low water flush, expeller, and mechanical seals.

## Wear service classification and operating limits

A primary factor is to identify the duty according to its Wear Service Class, using the guidelines given in Hydraulic Institute Standard ANSI/HI 12.1-12.6 "Rotodynamic (Centrifugal) Slurry Pumps"; see table below.

Wear service class	Slurry class	Metso Outotec's equivalent duty class	IAR Impeller Ø/Inlet Ø
1	Light	Mildly abrasive	≤ 2:1
2	Medium	Abrasive	2:1
3	Heavy	Highly abrasive	2.5:1
4	Very Heavy	Extremely abrasive	≥ 2.5:1

The Hydraulic Institute chart below can be used to assist in determining the wear service class.

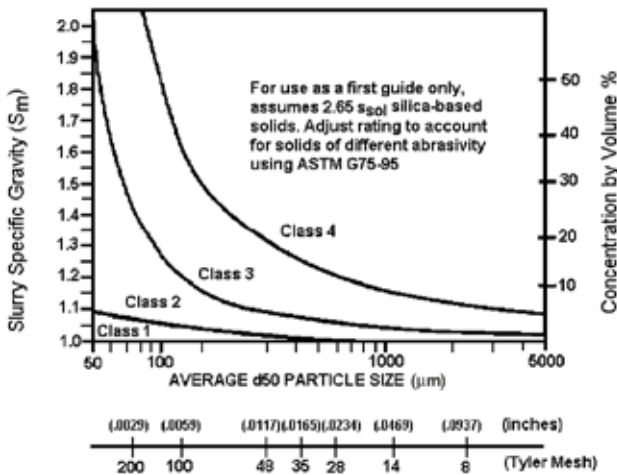

Wear service class chart for slurry pump erosive wear

Metso Outotec's guidelines for operating slurry pumps for obtaining satisfactory wear life are listed below:

Operating limits	Service class			
	1	2	3	4
Preferred Operating Range (POR) (% of BEP flow rate)	30 - 125 %	40 - 120 %	50 - 105 %	60 - 100 %

Maximum peripheral impeller speed: m/s (ft/s)	Service class			
	1	2	3	4
All-metal pump	46 (9055)	38 (7500)	33 (6500)	28 (5500)
Rubber lined pump	28 (5500)	28 (5500)	28 (5500)	28 (5500)
Metal impeller in rubber lined pump	32 (6300)	31 (6100)	30 (5900)	28 (5500)

PumpDim™ selection program use the Hydraulic Institute guidelines as well as proprietary information developed through analytical and experimental means. If in doubt, contact Metso Outotec Proposal Support.

## Performance loss

The graph below illustrates the loss in performance that can occur as parts wear away. Head/flow curve changes and power increases due to efficiency losses.

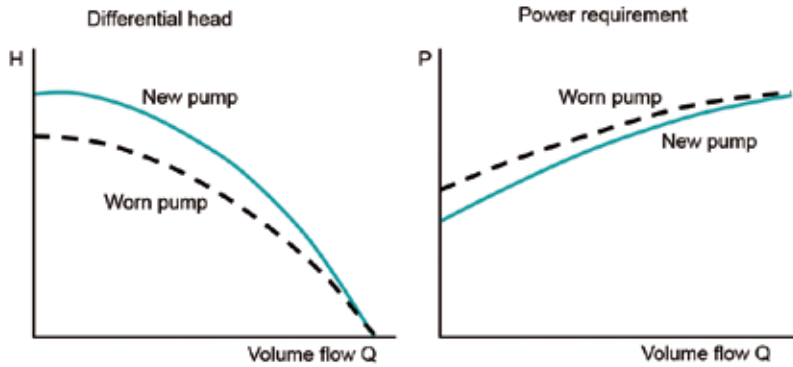

## Examples of worn parts from a variety of operating conditions.

### At BEP operation



### Right of BEP operation





Low flow – left of BEP operation

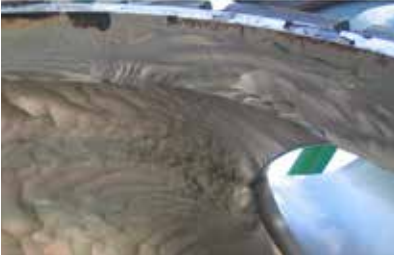

Corrosion examples



High Inlet velocities (coarse heavy solids).



High tip speed



Computational analysis

Metso Outotec uses information from installed and operating pumps, experimental data, and computational analysis to design, develop, and continually improve the product line. Images below show how computational fluid dynamics is used in the analysis process.

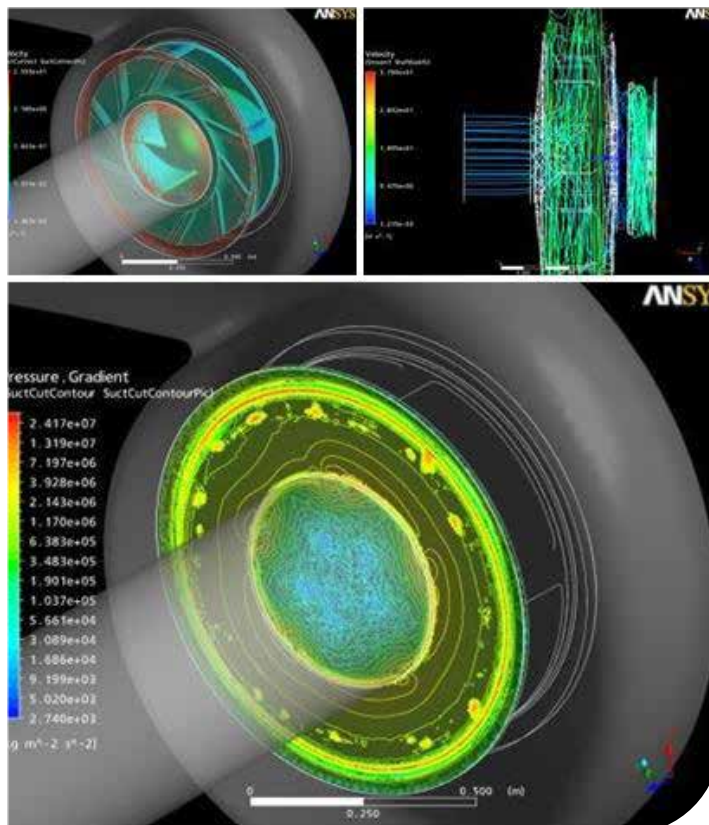

# 24. Foundations

## General

Refer to the Operation and Maintenance Manuals for detailed installation instructions.

### Foundation requirements

Ideally, the pump and its drive should be mounted on a common bedplate which is fixed to a level foundation of adequate strength. All bedplates supplied by Metso Outotec incorporate holding down bolt holes. It is recommended that the pump is installed in such a way that maintenance and adjustments can be carried out easily. It is essential that the pump is not subjected to flooding.

A foundation must provide a rigid and durable support, while absorbing shock loads and vibrations to and from the machine. Many criteria influence its design, its construction materials and its preparation: vibration and

loading characteristics, operating environment and effect of nearby machinery are some. Each installation is a special case needing careful examination of its particular requirements.

The suitability of existing foundations should be assessed by qualified personnel to ensure that the structures are capable of supporting the equipment and modifications carried out as required.

The following are general guidelines for preparing a newly poured foundation for Metso Outotec slurry pumps.

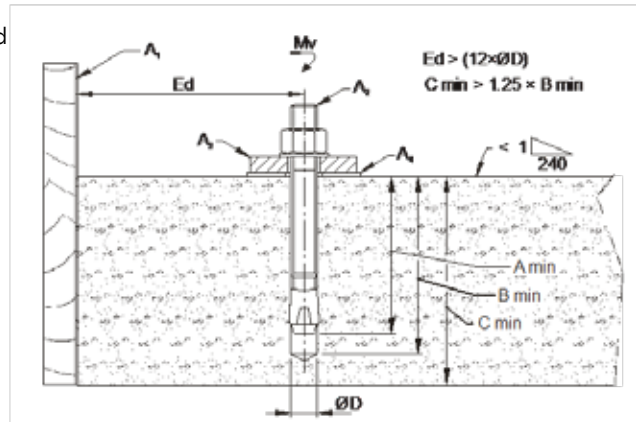

1. The foundation must be poured on a well prepared solid ground
2. A mixture of good quality cement and coarse aggregate is suitable in most cases. Where applicable, the physics and chemistry of the soil, the operating environment, and the local building regulations may impose additional requirements. Reinforcement bars may also be necessary depending on application
3. The total foundation mass and its related support structures should be at least five times the total weight of the rotating assembly. The weight of the rotating assembly — excluding the rotating parts of the motor — is roughly  $\frac{1}{4}$  of the weight of the bare shaft pump. See O&M Manuals for bare shaft assembly weights
4. Foundation depth ( $C_{min}$ ) should be at least 125 % of the anchor hole depth ( $B_{min}$ ). See Figure 1.
5. For maximum strength, anchor fixings should be positioned more than 12 times the anchor hole diameter ( $\text{ØD}$ ) from the edge of the concrete slab ( $E_d$ )
6. The concrete slab should be level to within 12.5 mm in 3000 mm (1" in 240")
7. If the installation is in close vicinity of other moving machinery, then necessary precautions should be taken to prevent cross-talk

# 25. Size reduction: Grinding

The **Basics in Mineral Processing Handbook** by **Metso Outotec** is a useful reference. The information below can also be found in that book.

The growth of civilizations over the centuries is closely tied to the understanding and development of minerals needed to produce useful materials that have enhanced living standards worldwide.

The goal in mineral processing is to produce maximum value from a given raw material. The end result can be a crushed product of a certain shape and size or the maximum recovery of metals out of a complex ore.

Raw material is obtained from surface and underground deposits. Quarries and mines are typical examples of sources.

Minerals being crystals can be broken into an endless number of sizes and shapes every time they are introduced to energy. Tensile, compressive, shear and attrition forces can be used to break down the materials as illustrated in Figure 1.

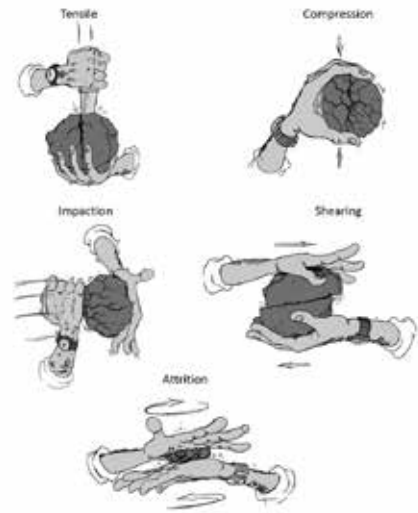

Figure 1

The challenges faced in size reduction lie in determining the proper limits of producing over and under sized materials.

Figure 2 shows a simple representation of a process flow.

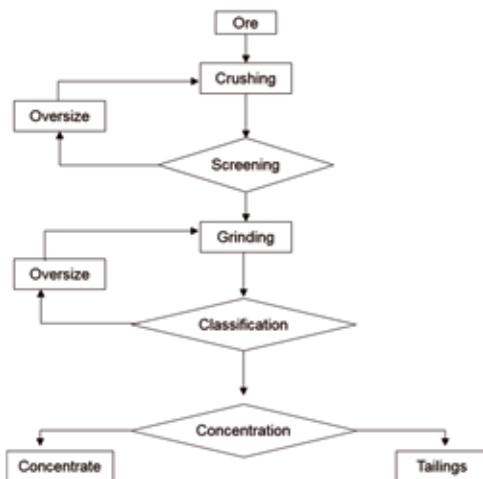

Figure 2

The purpose of grinding is to:

- Liberate individual minerals trapped in rock crystals (ores) for subsequent enrichment through a separation process.
- To produce fines (or filler) from mineral fractions.

The feed material, depending on its size and properties such as chemical composition and hardness, goes through a size reduction process.

Crushing and screening is the first controlled size reduction stage. This is the main process in aggregate production and sets the basis for further size reduction (below 5 - 20 mm).

Grinding is the second stage of size reduction (wet or dry) where the liberation size for specific minerals can be reached. Grinding is a powdering or pulverizing process that uses impact, compression, attrition and shear forces as depicted in Figure 3.

Different types of equipment are used to reduce the size to the desired fraction as shown in figure 4.

In order to liberate the value minerals from the host rock the target liberation size is normally in the 100 -10 micron range, see curve 1 in Figure 4. If the raw material is a single mineral then the value lays in the production of a fine powder (filler), see curve 2.

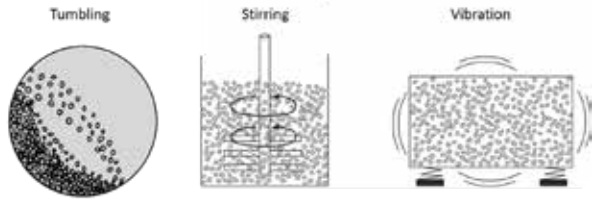

Figure 3

## Grinding strategies

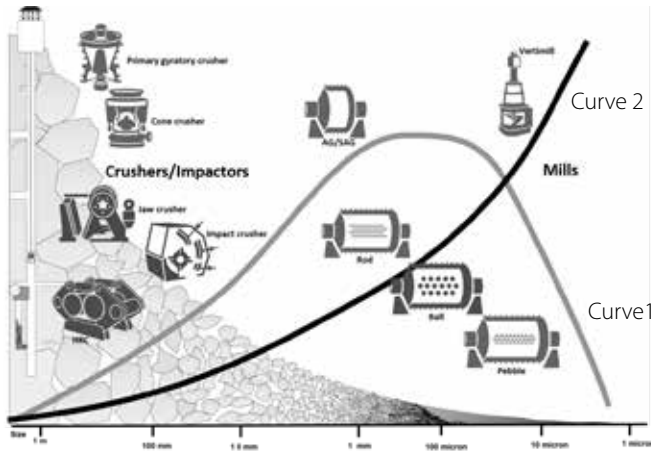

Figure 4

Ore composition dictates the different strategies and processing stages needed to liberate the minerals of interest. The microstructure as shown in figure 5 illustrate the need for this practice.

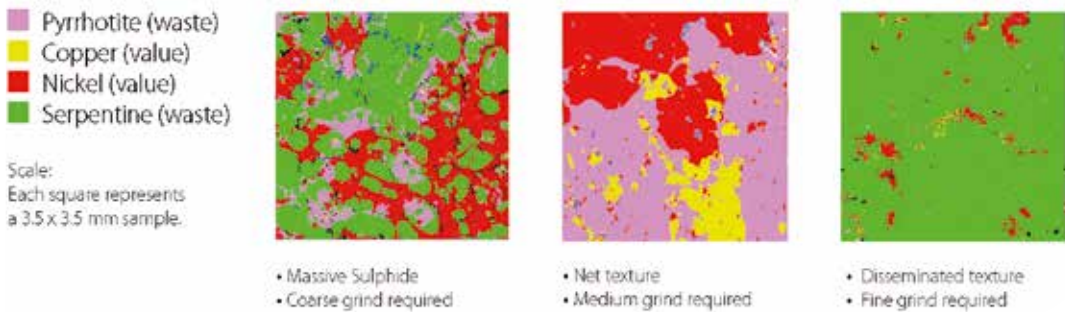

Figure 5



## Particle liberation

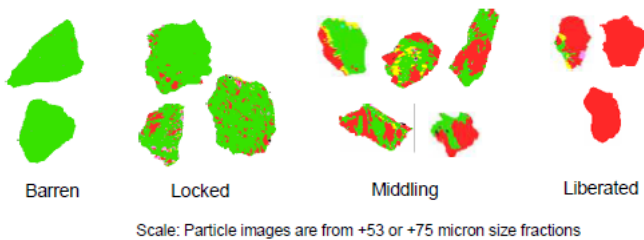

Figure 6

Mineral processing plants need to be designed to maximize the recovery of the minerals that are of interest. For the example below, several grinding and processing stages may be necessary to liberate the mineral (red) from the waste material (green) to arrive at an acceptable fraction.

## Grinding mills

All crushers, including impactors, have limited reduction ratios. Due to design constraints there is a restriction in retention time for the material being passed through. Grinding Mills, on the other hand, have more 'open space' and the retention time can be adjusted to meet the reduction requirements.

Several types of grinding mills are available for processing materials, each offering specific features suitable for the material being processed. Additionally, the costs for energy consumption, replacement liners and grinding media are different for each type. Information on the types of mills that are listed below can be found in the **Basics in Mineral Processing Handbook** by Metso Outotec.

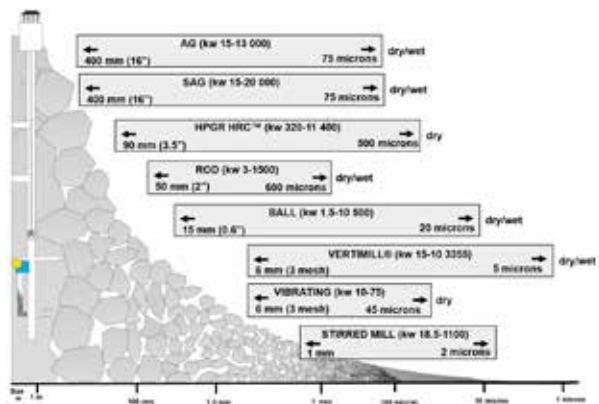

Figure 7

## Tumbling mills

- Autogenous (AG) mill
- Semi-Autogenous (SAG) mill
- Rod mill
- Ball mill
- Pebble mill
- Spherical roller antifriction bearing supported mill
- Conical ball mill
- Rubber roller mill

## Stirred mills

- VertiMill
- Stirred media grinding mill

## Vibrating mills

- Vibrating ball mill

The reduction ratio capabilities of mills are given in Figure 7.

Metso Outotec Proposal Support offers knowledgeable and skilled support in application analysis and equipment selection. Listed below are some of the steps used in mill sizing:

1. Operating data, if applicable, from existing mill circuits
2. Grinding tests on a pilot scale to determine specific power consumption for the grinding stages
3. Laboratory tests in small batch mills to determine specific power consumption
4. Energy and power calculations based on factors such as Grind Ability Index
5. Simulation techniques such as population balance modeling
6. Scale-up calculations for final sizing of equipment

## Grinding processes

Feed to the mill can be wet or dry depending on the subsequent process stages.

Dry grinding is necessary with some materials due to the physical or chemical changes which can occur when water is added.

For example, sodium bentonite is capable of absorbing 7 to 10 times its own weight in water and swelling up to 18 times in dry volume.

Wet grinding is generally used in mineral processing operations because of the economics associated with the overall cost of the operation. Advantages of wet grinding are:

- Lower power consumption per ton of product
- Higher capacity
- Closer product control by wet classification (screening or hydrocyclones)
- Elimination of dust problems
- Mill discharge is easier to handle and transport using slurry pumps and interconnecting pipes.

## Grinding processes

Grinding circuits are divided into two broad classifications:

**1. Open circuit:** The material is fed into the mill at a rate calculated to produce the correct product in one pass, typical circuit shown in Figure 8. Open circuits are rarely used in mineral processing applications as there is no control on the required product size

Feed rate must be low enough to ensure that every particle spends enough time in the mill to be broken down to the required product size. Many particles are over-ground which consumes additional energy.

**2. Closed circuit:** Material of the required size is removed by wet classification and the oversize returned to the mill feed for further processing, typical circuit shown in Figure 9. No effort is made to achieve the required size reduction in a single pass, instead, material is removed from the circuit as soon it reaches the required size.

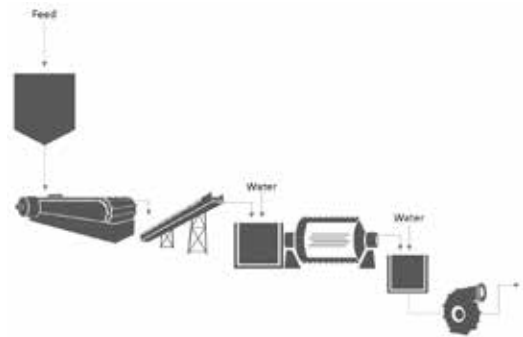

Figure 8

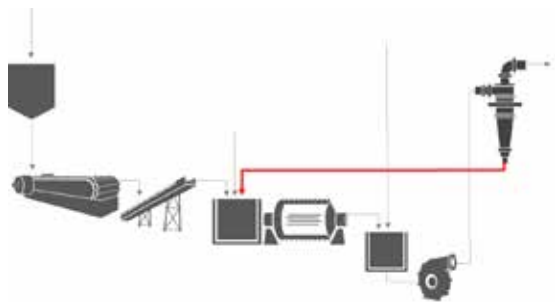

Figure 9: Single stage rod grinding and single classification circuit with circulating load shown in red.

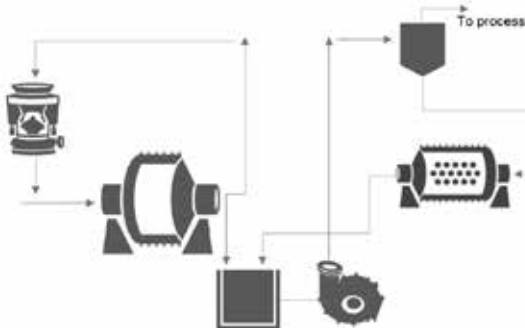

Figure 10: "ABC circuit": Autogenous mill, ball mill and crusher.

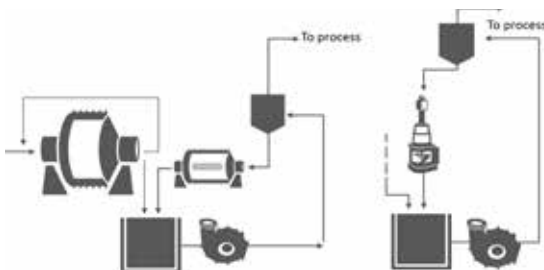

Figure 11: Autogenous mill, ball mill and VertiMill.

The material returned to the mill is known as the Circulating Load. Its weight is expressed as a percentage of the weight of the new feed and is typically in the 100 – 350 % range though it can be as high as 600 %. Variations in the Circulating Load can affect mill operations and have an impact on the slurry pumping performance.

Grinding circuits need to be designed to handle the size reduction processes efficiently and economically and, as a result, many circuit variations are used. Some examples are shown below in Figures 10 and 11.



## 26. Metso Outotec Mill Discharge (MD) pumps

Mill discharge pumps are used to move slurry for processing as the need dictates. The pumps have to be of a rugged design and operate reliably through production cycles until stopped for scheduled mill and supporting equipment maintenance.

Metso Outotec MD pumps can be used for the following applications:

- SAG/Ball mill discharge pumps
- Tailings pumps
- Hydrocyclone feed

Metso Outotec Mill Discharge pumps are built to offer several advantages:

- Computer aided design, coupled with years of practical experience, makes for high sustained efficiencies resulting in reduced wear and operating costs
- Large diameter, high efficiency impeller (high aspect ratio design) in high chromium delivers predictable performance over the life of the parts and ensures operation in the best efficiency range
- Abrasion resistant materials for wear parts – hard metal and rubber
- Extra thick sections at points of extreme wear –The extra weight pays off in performance and low maintenance costs
- Double adjustment – maintains performance through operating life
- Modular design and full interchangeability of parts
- Gland sealing – packed box as standard or optional low flush/mechanical seals
- Oil or grease lubricated bearings
- Vibration and temperature probe mount holes in bearing housing
- Back pull-out feature for ease of maintenance
- Manual or hydraulically operated slide bases available
- Impeller release mechanism – facilitates unscrewing of impeller from the shaft
- Ease of overall maintenance



*MDM – Metso Outotec  
Mill Discharge Metal pump*



*MDR – Metso Outotec  
Mill Discharge Rubber Lined pump*

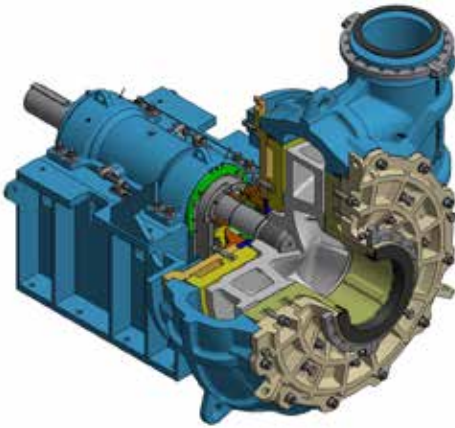

*Sectional view of Metso Outotec  
Mill Discharge Metal pump*

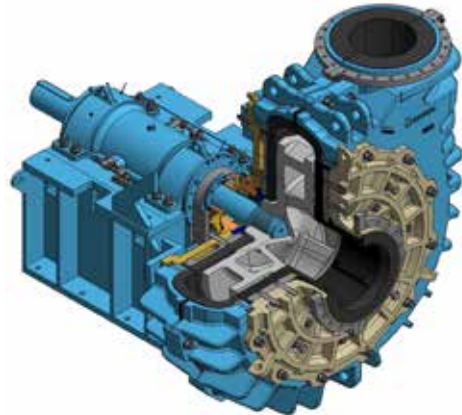

*Sectional view of Metso Outotec  
Mill Discharge Rubber pump*

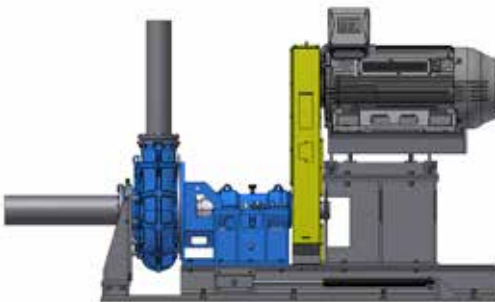

*Closed slide base*



*Open slide base*

## 27. Dredge pumps

Material can be dredged using mechanical or hydraulic methods. Draglines, long line excavators, hydraulic excavator shovels, clamshells, and bucket lines are examples of a mechanical means of dredging. Hydraulic dredging involves transporting slurry of material using a centrifugal pump.

Metso Outotec dredge pumps are commonly used for the following applications:

### Mining

- Sand and gravel production
- Mineral transport
- Tailings management
- Reclamation of land

### Environmental

- Removal and containment of hazardous materials
- Reclamation of habitat
- Environmental enhancement

### Navigation

- Channel construction and maintenance
- Harbor deepening
- Land reclamation and creation

Metso Outotec dredge pumps are built to offer several advantages:

- Advances in design provide improved hydraulic efficiencies so that units can be sized and selected to operate close to the Best Efficiency Point (BEP) resulting in reduced wear and operating costs
- Extra heavy metal sections to allow for long wear life
- Abrasion resistant metallurgy for wear parts
- Knock-out ring for easy impeller removal
- Suction adapter with clean-out
- Gland sealing – packed box as standard or optional low/non flush seals
- Bearings suitable for underwater applications are an option

Metso Outotec supplies pumps to dredge manufacturers and sells them in the aftermarket too. Dredge pumps can be hull, deck, and ladder mounted depending on user requirements. They can also be land or water based for use as booster pumps.

Hull and deck mounted dredge pumps work well for moving material for depths up to 12 m (40 ft). Beyond these depths, ladder (underwater) mounted pumps, or deck/hull mounted pump with a Hydra-Jet addition are used to increase production.

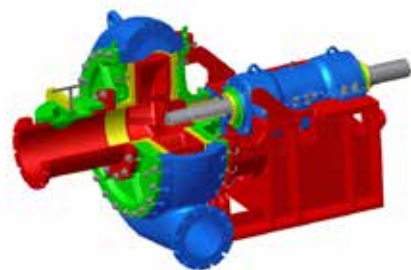

*Sectional view of a Metso Outotec dredge pump*

Deck mounted dredge pumps are easy to install and maintain, however they can offer 10 - 15 % less production than a hull mounted pump and can be difficult to prime.

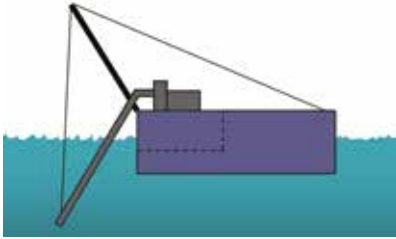

*Sketch of a deck mounted dredge pump*

Hull mounted dredge pumps offer increased production and are easier to prime.

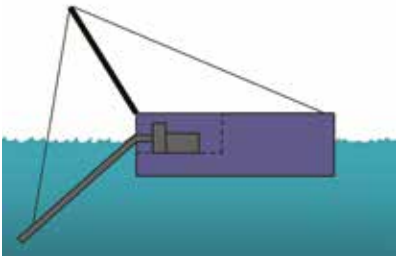

*Sketch of a hull mounted dredge pump.*

Ladder (underwater) mounted dredge pumps offer higher production at dredging depths over 12 m (40 ft). Installation costs are higher due to the structural requirements of the dredge to support the weight of the pump and associated equipment.

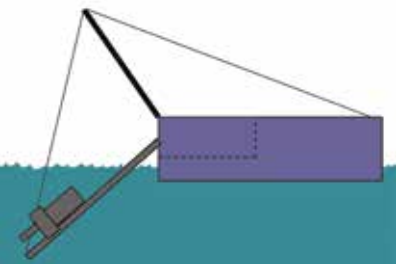

*Sketch of a ladder mounted dredge pump.*



*Land based booster dredge pump*

## Metso Outotec Hydra-Jets

Hydra-Jets can be used to improve suction feed at depths up to 36.5m (120 ft). A Hydra-Jet is installed in the suction pipe of a dredge and is a device through which high pressure water is pumped.

The water flows into a venturi which is a specially designed nozzle. The increase in velocity through the venturi results in a reduction in the local pressure.

The increase in differential pressure (surrounding pressure less the locally reduced pressure) forces the mixture of water and dredged material up the suction pipe. This action provides the following benefits:

- An increase in the percent of solids in the slurry, thus increasing production.
- As an aid in priming the pump.
- To help reduce cavitation in the pump.
- Increased dredging depths.



Twin Hydra-Jet

Hydra-Jets can be of the single or twin type design. They have been installed on open suction dredges, cutter-suction dredges and dredges equipped with a chain-type digging ladder.

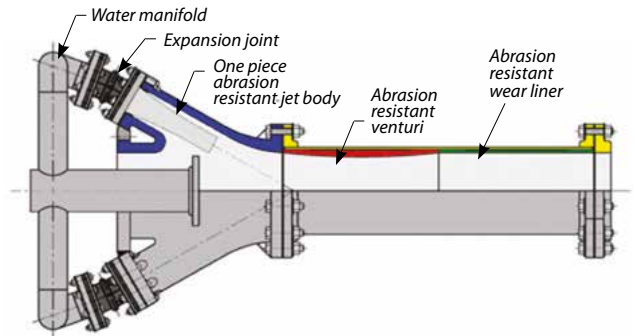

Twin Hydra-Jet system

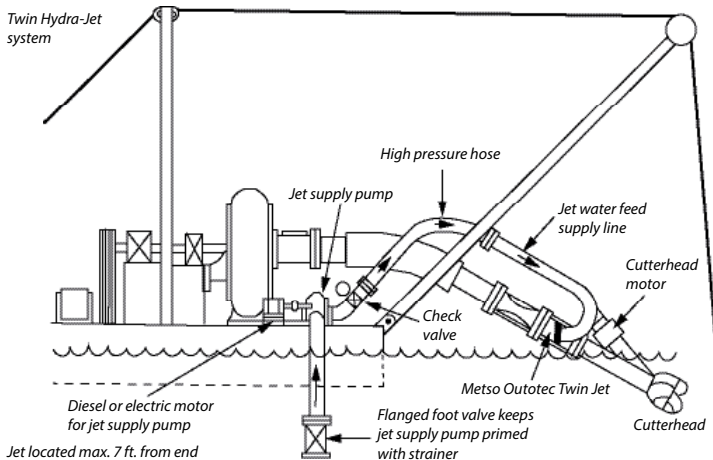

The brief description above of dredge pumping shows that these applications can be complex in nature. Metso Outotec's PumpDim™ program can be used to size Metso Outotec's standard dredge pumps. However, it is recommended that Metso Outotec Proposal Support be contacted for support and assistance in the selection process. See page 60 and 69 for dredge pump models and sizes.

## 28. Slurry transport

The **Metso Outotec Slurry Hose System Design Manual** is a useful reference offering advice and instructions on the installation of Metso Outotec piping used in slurry transportation. A significant amount of the information below is from that document.

Piping used in slurry handling applications should be sized and selected to provide long wear life, ease of maintenance, and economical power consumption. Piping is available in steel, elastomer-lined steel, or non-metallic materials such as rubber, plastic, and concrete.

Steel pipelines are used for high pressures and when the slurry is relatively fine and not corrosive. Thick walled pipe can be used to prolong operating life from wear and corrosion. In some instances, more expensive special hardened steels are used but significant improvement in wear life has not been observed.

To increase wear resistance, pipes are often lined with different kinds of materials. Rubber lined steel pipes are used for transportation of wearing material under high pressures and the service life of the pipeline is prolonged considerably.

Rubber pipes offer superior wear resistance when handling abrasive slurry material. When used with rubber lined steel pipes, the combination allows for excellent flexibility in piping layout and the ability to make future changes with minimal structural modifications.

Plastic pipes can be used for transporting fine materials under low pressures and velocities. Some benefits are their light weight, better corrosion resistance compared to steel, and low friction losses but some of the drawbacks are limited wear resistance and high coefficient of expansion. Concrete pipes have high friction losses and may be suitable for limited applications only.

### Applications

Slurry hose, in conjunction with lined pipe, can be used in many industries and some examples of these applications are given below.

#### Mining Industry

Transportation of crushed ore, ground, ore and waste products.

#### Stone and Gravel Industry

Transportation of sand, gravel, crushed rock, and ground rock.

#### Cement Industry

Transportation of lime slurry and chalk.

#### Chemical Industry

Transportation of leached uranium ore, granular gypsum, phosphate slurry, china clay, fluorspar, and salt.

#### Steel Works

Transportation of oxide scale in suspension.

#### Coal Industry

Transportation of coal slurry in washing plants.

## Slurry Pipeline sizing

The following factors have a significant effect on the selection and sizing of a slurry transport pipeline because they are related to the wear life, power consumption, maintenance, and operating costs in an application.

### Particle characteristics

- Size
- Size distribution
- Shape
- Hardness
- Density (concentration)
- Temperature

### Pipe conditions

- Pipe material or pipe lining material
- Diameter
- Circuit layout – bends, inclination, uneven path of piping

### Liquid characteristics

- Density
- Viscosity
- Temperature
- pH

### Type of flow

- Laminar or turbulent
- Heterogeneous or homogeneous
- Flow velocity

## Flow regimes

Large particles are more difficult to keep in suspension than small ones in a slurry mixture. At low flow velocities, particles will have a tendency to settle out in a pipeline. Therefore, low velocity conditions can result in blockages whereas high velocities increase friction losses.

Flow regimes can be described as stationary bed, sliding bed, heterogeneous, and homogeneous.

Stationary bed conditions should be avoided because these will cause production problems. Sliding bed conditions may be acceptable in some applications that have short pipelines but are not recommended.

Homogeneous and heterogeneous flow conditions are preferred for slurry transport. Slurry with uniform particle distribution in the pipe cross-section and particle size smaller than  $50\mu\text{m}$  ( $0.002''$ ) is classified as a homogeneous suspension. Rheological properties of such mixtures should be determined so as to account for viscosity effects that will occur under operating conditions.

Compared to homogeneous suspensions, heterogeneous suspensions have larger particles which are suspended mainly through liquid turbulence. Flow velocities should be above a 'critical velocity' so as to prevent sedimentation or clogging in the pipeline. Critical velocity calculations are a function of particle size, particle density, pipe diameter, and volumetric concentration.

Figures 1 to 3 provide a visual overview and explanation of the above commentary.

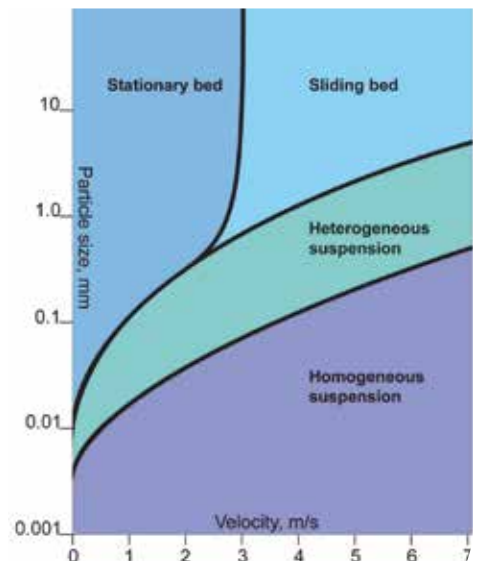

Figure 1: Example of flow configurations (sand density =  $2700\text{ kg/m}^3$ , pipe diameter =  $160\text{ mm}$ )



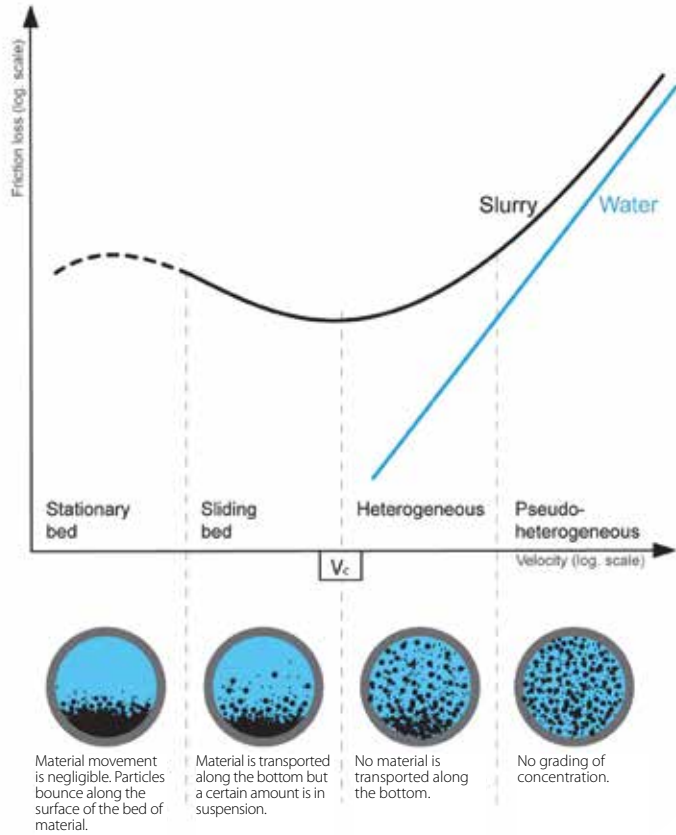

Figure 2: Relationship between different flow conditions and friction losses



Figure 3: Different flow conditions. The lowest variant represents the preferred flow conditions.



## Wear

Particle shape, hardness, concentration of solid material, and flow velocity affect wear in pipelines. Improperly sized piping, misaligned connections, sharp bends, uneven path, and inclination of piping are factors that also have to be considered in the design of a circuit. The life cycle can be extended if, where possible, piping can be rotated at specified maintenance intervals resulting in uniform wear of the part.

Wear in slurry handling equipment can be caused by sliding, cutting, and crushing actions of the solids. Pipelines mostly see sliding wear although cutting wear can also occur. Crushing wear is mostly non-existent in pipelines.

The angle of incidence at which particles impact the pipe surface is important in the wear process. Low angles of incidence, common in sliding wear, are ideal for rubber surfaces and result in superior wear resistance. See example below in Figure 4 of the economic benefits of an application using a rubber surface in slurry transport.

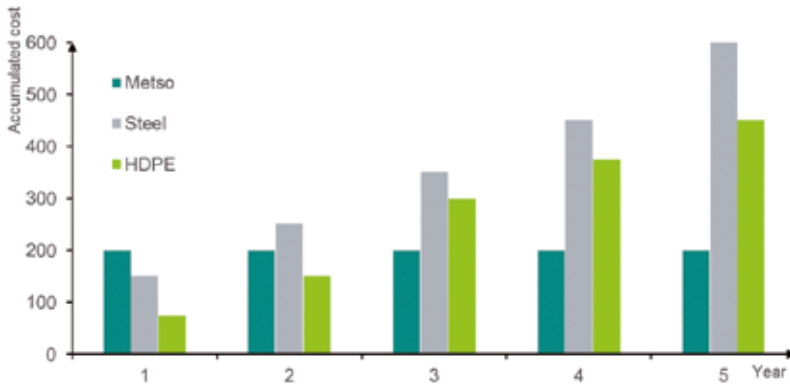

Figure 4: A cost comparison between Metso Outotec, conventional steel pipes and HDPE, based on the following operational date: 2 lines with total length of approx. 100ft (300m) having an inside diameter of 6 in. (152 mm) for carrying slurry (35% solid material of diabase and gneiss with a particle size up to 3/16 in. (5mm) Working pressure 75 psi (5kp/cm<sup>2</sup>). Flow rate 11 ft/sec (3.3 m/s). Capacity 140 000 tons of solid material per year.

## Metso Outotec Hose and Lined Pipe

Rubber hose and rubber lined steel pipe is available over a wide range of diameters and, depending on size, working pressures up to 25 Bar (360 psi). The hose can withstand certain vacuum conditions. Chemical resistance depends on factors such as temperature, concentration, pressure, flow rate, exposure time, and liquid stability.

Hose is made by winding several layers of different materials on a rubber Wear Tube as depicted in the Figure 5 below. The windings are laid in a specially predetermined pattern to provide the reinforcement necessary to withstand the rated pressures. A vulcanizing process bonds the components to make a solid assembly. The outer cover protects the reinforcements from external damage such as abrasion, corrosion, sunlight, and ozone.

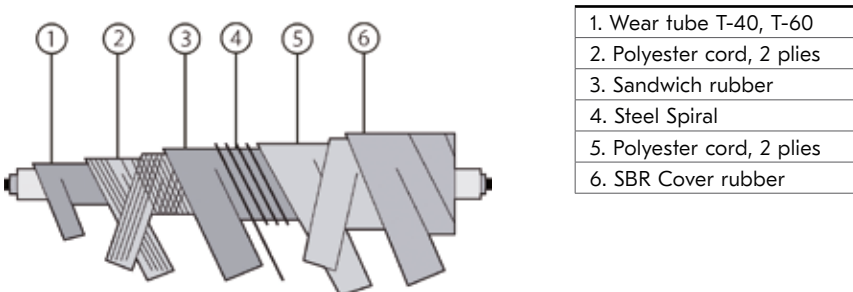

Figure 5

Rubber lined steel pipe can be used in straight runs and can be self-supporting whereas a support structure is recommended for hose. The pipe and hose can be connected with the aid of split-flange couplings and gaskets for an obstruction free joint.

Other accessories such as bends, branch pipes, reducers, compensators, and dart valves are available and provide the flexibility required to build a complete circuit. Figures 6 - 9 and pictures 1-5 illustrate several piping components and piping layouts.



Figure 6: Branch Pipe 90°



Figure 7: Compensator

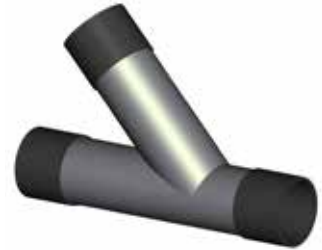

Figure 8: Branch Pipe 45°



Figure 9: Example of Slurry Hose Piping and connectors

Accessories:

1. Rubber Lined Steel Pipe
2. Coupling
3. 3xD Rubber Bend
4. Rubber Lined Steel Reducer
5. Branch Pipe

## Examples of installations using Metso Outotec slurry hose and piping



Picture 1: Material handling hose and rubber lined steel pipe



Picture 2: Material handling hose with support beam and clamps



Picture 3: Material handling hose, rubber lined steel pipe, 3xD 90 Degree bend and support clamps



Picture 4: Material handling hose with 3x90 degree bend



Picture 5: Rubber lined steel pipe and compensator

## 29. Slurry valves

Valves are a necessity in any piping circuit. They aid in controlling flow in all types of operating conditions, from start-up, during production cycles, and at shut-down.

Valves come in many designs, such as gate, pinch, ball, butterfly, and plug to name a few. Operation can be manual, pneumatic, hydraulic, or electric. Additional features can be added to automate the control process and optimize performance.

Valves handling solids laden fluids, as compared to those for clear fluids, face severe performance demands and they have to be of a robust design to function reliably in order to withstand the wear and tear that can occur in such applications. Valve designs are therefore limited to specific types as is described here.

### Applications

Slurry valves are used in many mineral processing applications and some of the industries served are listed below.

- Mining
- Oil Sands
- Pulp and Paper
- Stone and Gravel
- Cement
- Chemical
- Steel Works
- Coal

### Slurry valve sizing

Valve and piping selection in slurry applications requires skilled system analysis and support from personnel with expertise in this field. The following factors have a significant effect on the selection and sizing of a slurry valve because they are related to the wear life, power consumption, maintenance, and operating costs in an application.

#### Particle characteristics

- Size
- Size distribution
- Shape
- Hardness
- Density (concentration)
- Temperature

#### Liquid characteristics

- Density
- Viscosity
- Temperature
- pH

#### Type of flow

- Laminar or turbulent
- Heterogeneous or homogeneous
- Flow velocity

#### Pipe conditions

- Pipe material or pipe lining material
- Diameter
- Circuit layout — used to define valve location

### Flow regimes

See Chapter 19-Slurry transport for more information on this subject. Flow regimes in a circuit can be described as stationary bed, sliding bed, heterogeneous, and homogeneous. Stationary and sliding bed conditions are not recommended. Homogeneous and heterogeneous flow conditions are preferred for slurry transport.

### Wear

In slurry handling applications, equipment will commonly see abrasive, erosive, and corrosive wear. These three can occur individually or in combination depending on the factors given above. Valves, for example, can see:

- Abrasion when particles get trapped between surfaces moving relative to each other
- Erosion when particles impact surfaces at different angles and depends on conditions such as high flow velocities, cavitation, particle characteristics, and valve setting
- Corrosion is due to chemical attack on materials that are incompatible with the fluid being pumped



## Metso Outotec slurry valves

Metso Outotec slurry valves used in mineral processing applications are of the following designs. Contact Metso Outotec Proposal Support for technical assistance in the selection process.

### Knife gate valves

These valves are suitable for most abrasive slurries and the 'full-bore' design with shut-off isolation features offer bi-directional operational reliability. Actuation by manual, pneumatic, or other means is possible.

In the open setting, the elastomeric seats seal tightly against each other when the gate is fully withdrawn out of the flow stream. Only the seats are exposed to the slurry while providing a full-bore opening and no area for media build up.

During the closing action the seats are axially separated and seal against the gate. Residue can be discharged from the bottom of the valve at the end of the cycle.



Open



Open



Closed

The table below lists sizes available and the pressure ratings.

Size range	· DN 50 – DN 600 · ASME 2" – 24"	
Pressure rating	Flange	Max. differential pressure at ambient temperature
	DN 50 – DN 400	10 bar
	DN 450 – DN 600	5 bar
	ANSI 2" – 16"	150 psi
	ANSI 18" – 24"	75 psi

Temperature rating and chemical resistance depend on the type of elastomer used. If in doubt, contact Metso Outotec Proposal Support.

### Dart valves

Dart valves are used for flow shut off inside sump tanks with vertical outlets. They are suitable for applications handling abrasive slurries, powders, and granular substances. The valve and seat are elastomer lined over all the surfaces that come in contact with slurry. There is no flow restriction in the open position.

The inside diameter of the seat is the same as the Slurry Hose System offered by Metso Outotec. Valves from DN100 – DN600 mm (4"-24") sizes in DIN flanges are available. Pneumatic, hydraulic, or electrically operated actuators can be used for regulating the dart valve.

Examples of Metso Outotec Slurry Hose and Valve installations.

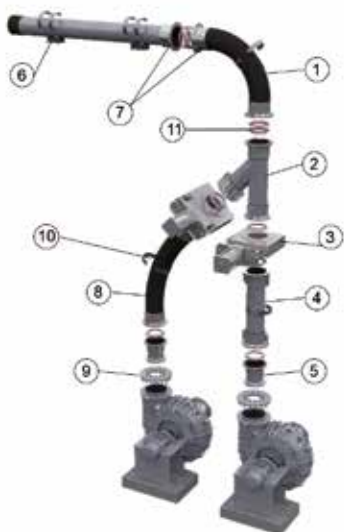

- |                               |
|-------------------------------|
| 1. Metso Outotec 3xD Bend 90° |
| 2. Branch Pipe K45            |
| 3. Knife Gate Valve           |
| 4. Rubber Lined Steel Pipe    |
| 5. Rubber Lined Steel Reducer |
| 6. Sliding Support Clamp      |
| 7. Aluminum Coupling          |
| 8. Material Handling Hose     |
| 9. Flange Adaptor             |
| 10. Support Clamp             |
| 11. Trellex Gasket            |



- |                                  |
|----------------------------------|
| 1. Flange Adapter                |
| 2. Rubber Lined Steel Reducer    |
| 3. Branch Pipe T90 inlet water   |
| 4. Branch Pipe T90 drainage      |
| 5. Metso Outotec 3xD Bend        |
| 6. Metso Outotec Dart Valve Seat |
| 7. Metso Outotec Dart Valve      |



- |                                |
|--------------------------------|
| 1. Flange Adapter              |
| 2. Rubber Lined Steel Reducer  |
| 3. Rubber Compensator          |
| 4. Branch Pipe T90 inlet water |
| 5. Branch Pipe T90 drainage    |
| 6. Knife Gate Valve            |





*Sump tank with shut off valve*



*Shut off valve for slurry pump line with K45 branch pipe*

Contact Metso Outotec Proposal Support for technical assistance in the selection process.

# 30. Miscellaneous

## Conversion factors

Length		
1 inch	=	25.4 mm
1 foot	=	0.305 m
Area		
1 square inch	=	645 mm <sup>2</sup> = 6.45 cm <sup>2</sup>
1 square foot	=	0.0929 mm <sup>2</sup> = 929 cm <sup>2</sup>
Volume		
1 cubic inch	=	16.4 cm <sup>3</sup>
1 cubic foot	=	28.3 l
1 UK gallon	=	4.55 l
1 US gallon	=	3.79 l
Mass		
1 pound (lb)	=	0.454 kg
1 ounce (oz)	=	28.3 g
1 short ton	=	907 kg
Spec. gr.		
1 lb/in <sup>3</sup>	=	27.7 t/m <sup>3</sup> = 27.7 g/cm <sup>3</sup>
1 lb/ft <sup>3</sup>	=	16.0 kg/m <sup>3</sup>
Force		
1 kp (kgf)	=	9.81 N
1 lbf	=	4.45 N
Energy		
1 kWh	=	3.60 MJ
1 kcal	=	4.19 kJ
1 Btu	=	1.06 kJ
Power		
1 kcal/h	=	1.16 W
1 hp	=	746 W
Pressure		
1 bar	=	14.5 PSI = 100 kPa
1 bar	=	100 kPa
1 kp/cm <sup>2</sup>	=	98.1 kPa
1 atm	=	760 torr = 101 kPa
1 lbf/in <sup>2</sup> (psi)	=	6.89 kPa = 0.07031kp/cm <sup>2</sup>
1 torr (mm Hg)	=	133 Pa

Torque			
1 ft. lb	=	1.356 Nm	
Dynamic viscosity			
N s/m <sup>2</sup>	N s/mm <sup>2</sup>	P	cP
1	10 <sup>-6</sup>	10	10 <sup>3</sup>
10 <sup>6</sup>	1	10.10 <sup>6</sup>	10 <sup>9</sup>
0.1	0.1. 10 <sup>-6</sup>	1	100
10 <sup>-3</sup>	10 <sup>-9</sup>	10. 10 <sup>-3</sup>	1
Kinematic viscosity = dynamic viscosity density			
m <sup>2</sup> /s	St (Stoke)	St (Stoke) cSt	
1	10. 10 <sup>3</sup>	10. 10 <sup>3</sup>	
10 <sup>-6</sup>	10. 10 <sup>-3</sup>	10. 10 <sup>-3</sup>	
0.1. 10 <sup>-3</sup>	1	1	
Flow			
1 usgpm	=	0.23 m <sup>3</sup> /h	
1 lgpmp	=	0.276 m <sup>3</sup> /h	
Velocity			
1 fps	=	0,3408 m/s	
1 fpm	=	18.288 m/min	
Concentration clarity			
ppm = parts per million = mg/l			
ppb = parts per billion = mg/m <sup>3</sup>			
SS = suspended solids			
TS = total solids ( incl. dissolved solids)			

## Tyler standard scale

Mesh	Micron	Mesh	Micron	Mesh	Micron
2 1/2	8000	14	1180	80	180
3	6700	16	1000	100	150
3 1/2	5600	20	850	115	125
4	4750	24	710	150	106
5	4000	28	600	170	90
6	3350	32	500	200	75
7	2800	35	425	250	63
8	2360	42	355	270	53
9	2000	48	300	325	45
10	1700	60	250	400	38
12	1400	65	212	500	25

## Density of solids

	Mineral	Relative density
A	Albite	2.6
	Almandine	4.3
	Anatase	3.9
	Andradite	3.8
	Apatite	3.2
	Arsenopyrite	5.9-6.2
	Asbestos	2.4-2.5
	Azurite	3.8
B	Baddeleyite	5.6
	Barite	4.5
	Bauxite	2.6
	Beryl	2.7-2.8
	Biotite	3.0-3.1
	Bismuth	9.8
C	Calcite	2.7
	Cassiterite	7.0
	Celestite	4.0
	Cerussite	6.6
	Chalcocite	5.5-5.8
	Chalcopyrite	4.1-4.3
	Chlorite	2.6-3.2
	Chromite	5.1
	Chrysocolla	2.0-2.3
	Cinnabar	8.1
	Cobaltite	6.0-6.3
	Colemanite	2.4
	Copper	8.9
	Corundum	3.9-4.1
	Covellite	4.7
	Cryolite	3.0
	Cuprite	5.8-6.2
D	Diamond	3.5
	Diopside	3.3-3.4
	Dolomite	1.8-2.9
E	Epidote	3.4
F	Feldspar Group	2.6-2.8
	Ferberite	7.5
	Ferrosilicon	6.8
	Flint	2.6
	Fluorite	3.2
	Franklinite	5.1-5.2
G	Gahnite	4.6
	Galena	7.5
	Goethite	4.3
	Gold	15.6-19.3
	Graphite	2.1-2.2
	Grossularite	3.5
	Gypsum	2.3

	Mineral	Relative density
H	Halite	2.5
	Hematite	5.2
	Hornblende	3.1-3.3
	Huebnerite	6.7-7.5
	Hypersthene	3.4
I	Ilmenite	4.7
K	Kaolinite	2.6
	Kyanite	3.6-3.7
L	Lepidolite	2.8-2.9
	Limonite	2.2-2.4
M	Magnesite	3.0
	Magnetite	4.7
	Malachite	4.0
	Magnite	4.3
	Marcasite	4.6-4.9
	Martite	5.2
	Microcline	2.6
	Microlite	5.5
	Molybdenite	4.7-5.0
	Monazite	4.9-5.5
	Mullite	3.2
N	Muscovite	2.8-3.0
	Nepheline	2.6
	Syenite	2.6
O	Niccolite	7.6-7.8
	Olivine	3.3-3.5
	Orpiment	3.4-3.5
	Orthoclase	2.5-2.6
	Petalite	2.4
P	Platinum	14.0-21.5
	Pyrite	5.0
	Pyrochlore	4.2-4.4
	Pyrolusite	4.7-5.0
	Pyroxene	3.1-3.6
Q	Pyrrhotite	4.6-4.7
	Quartz	2.7
R	Realgar	3.6
	Rhodochrosite	3.7
	Rhodonite	3.6-3.7
	Rutile	4.2-4.3

	Mineral	Relative density
S	Scheelite	6.1
	Serpentine	2.5-2.7
	Siderite	3.9
	Sillimanite	3.2
	Silver	10.1-11.1
	Smithsonite	4.1-4.5
	Sphalerite	3.9-4.0
	Sphene	3.3-8.6
	Spinel	3.6
	Spodumene	3.1-3.2
	Stannite	4.3-4.5
	Stibnite (Antimonite)	4.6
	Sulphur	2.1
Sylvite	2.0	
T	Talc	2.7-2.8
	Tantalite	5.2-8.2
	Tetrahedrite	5.0
	Thorite	4.5-5.4
	Topaz	3.5-3.6
	Tourmaline	2.9-3.2
U	Uraninite	11.0
V	Vermiculite	2.4-2.7
W	Wolframite	6.7-7.5
	Wollastonite	2.8-2.9
Z	Zeolite	2.0-2.5
	Zincite	5.7
	Zircon	4.7

Other solids of varying composition:	
Slag	1.5-4
Soil	1.5-2.8
Ash (fly)	1.5-3.5
Ash (bottom)	1.5-3
Wet scrubber effluent	2-5
Mill scale	4.9-5.2

## Water and solids – Pulp density data

A = Solids by weight [%]

B = Pulp density [ton/m<sup>3</sup>]

C = Pulp volume [m<sup>3</sup>/ton solids]

Density of solids: 1.4						Density of solids: 1.8					
A	B	C	A	B	C	A	B	C	A	B	C
1	1.003	99.714	41	1.133	2.153	1	1.004	99.556	41	1.223	1.995
2	1.006	49.714	42	1.136	2.095	2	1.009	49.556	42	1.230	1.937
3	1.009	33.048	43	1.140	2.040	3	1.014	32.889	43	1.236	1.881
4	1.012	24.714	44	1.144	1.987	4	1.018	24.556	44	1.243	1.828
5	1.014	19.714	45	1.148	1.937	5	1.023	19.556	45	1.250	1.778
6	1.017	16.381	46	1.151	1.888	6	1.027	16.222	46	1.257	1.729
7	1.020	14.000	47	1.155	1.842	7	1.032	13.841	47	1.264	1.683
8	1.023	12.214	48	1.159	1.798	8	1.037	12.056	48	1.271	1.639
9	1.026	10.825	49	1.163	1.755	9	1.042	10.667	49	1.278	1.596
10	1.029	9.714	50	1.167	1.714	10	1.047	9.556	50	1.286	1.556
11	1.032	8.805	51	1.171	1.675	11	1.051	8.646	51	1.293	1.516
12	1.036	8.048	52	1.174	1.637	12	1.056	7.889	52	1.301	1.479
13	1.039	7.407	53	1.178	1.601	13	1.061	7.248	53	1.308	1.442
14	1.042	6.857	54	1.182	1.566	14	1.066	6.698	54	1.316	1.407
15	1.045	6.381	55	1.186	1.532	15	1.071	6.222	55	1.324	1.374
16	1.048	5.964	56	1.190	1.500	16	1.077	5.806	56	1.331	1.341
17	1.051	5.597	57	1.195	1.469	17	1.082	5.438	57	1.339	1.310
18	1.054	5.270	58	1.199	1.438	18	1.087	5.111	58	1.347	1.280
19	1.057	4.977	59	1.203	1.409	19	1.092	4.819	59	1.355	1.250
20	1.061	4.714	60	1.207	1.381	20	1.098	4.556	60	1.364	1.222
21	1.064	4.476	61	1.211	1.354	21	1.103	4.317	61	1.372	1.195
22	1.067	4.260	62	1.215	1.327	22	1.108	4.101	62	1.380	1.168
23	1.070	4.062	63	1.220	1.302	23	1.114	3.903	63	1.389	1.143
24	1.074	3.881	64	1.224	1.277	24	1.119	3.722	64	1.398	1.118
25	1.077	3.714	65	1.228	1.253	25	1.125	3.556	65	1.406	1.094
26	1.080	3.560	66	1.232	1.229	26	1.131	3.402	66	1.415	1.071
27	1.084	3.418	67	1.237	1.207	27	1.136	3.259	67	1.424	1.048
28	1.087	3.286	68	1.241	1.185	28	1.142	3.127	68	1.433	1.026
29	1.090	3.163	69	1.246	1.164	29	1.148	3.004	69	1.442	1.005
30	1.094	3.048	70	1.250	1.143	30	1.154	2.889	70	1.452	0.984
31	1.097	2.940	71	1.254	1.123	31	1.160	2.781	71	1.461	0.964
32	1.101	2.839	72	1.259	1.103	32	1.166	2.681	72	1.471	0.944
33	1.104	2.745	73	1.264	1.084	33	1.172	2.586	73	1.480	0.925
34	1.108	2.655	74	1.268	1.066	34	1.178	2.497	74	1.490	0.907
35	1.111	2.571	75	1.273	1.048	35	1.184	2.413	75	1.500	0.889
36	1.115	2.492	76	1.277	1.030	36	1.190	2.333	76	1.510	0.871
37	1.118	2.417	77	1.282	1.013	37	1.197	2.258	77	1.520	0.854
38	1.122	2.346	78	1.287	0.996	38	1.203	2.187	78	1.531	0.838
39	1.125	2.278	79	1.292	0.980	39	1.210	2.120	79	1.541	0.821
40	1.129	2.214	80	1.296	0.964	40	1.216	2.056	80	1.552	0.806

## Water and solids – Pulp density data (US)

A = Solids by weight [%]

B = Pulp S. G.

C = Pulp volume USG/ton solids

Density of solids: 1.4						Density of solids: 1.8					
A	B	C	A	B	C	A	B	C	A	B	C
1	1.003	23897	41	1.133	516	1	1.004	23859	41	1.223	478
2	1.006	11914	42	1.136	502	2	1.009	11876	42	1.230	464
3	1.009	7920	43	1.140	489	3	1.014	7882	43	1.236	451
4	1.012	5923	44	1.144	476	4	1.018	5885	44	1.243	438
5	1.014	4725	45	1.148	464	5	1.023	4687	45	1.250	426
6	1.017	3926	46	1.151	452	6	1.027	3888	46	1.257	414
7	1.020	3355	47	1.155	441	7	1.032	3317	47	1.264	403
8	1.023	2927	48	1.159	431	8	1.037	2889	48	1.271	393
9	1.026	2594	49	1.163	421	9	1.042	2556	49	1.278	382
10	1.029	2328	50	1.167	411	10	1.047	2290	50	1.286	373
11	1.032	2110	51	1.171	401	11	1.051	2072	51	1.293	363
12	1.036	1929	52	1.174	392	12	1.056	1891	52	1.301	354
13	1.039	1775	53	1.178	384	13	1.061	1737	53	1.308	346
14	1.042	1643	54	1.182	375	14	1.066	1605	54	1.316	337
15	1.045	1529	55	1.186	367	15	1.071	1491	55	1.324	329
16	1.048	1429	56	1.190	359	16	1.077	1391	56	1.331	321
17	1.051	1341	57	1.195	352	17	1.082	1303	57	1.339	314
18	1.054	1263	58	1.199	345	18	1.087	1225	58	1.347	307
19	1.057	1193	59	1.203	338	19	1.092	1155	59	1.355	300
20	1.061	1130	60	1.207	331	20	1.098	1092	60	1.364	293
21	1.064	1073	61	1.211	324	21	1.103	1035	61	1.372	286
22	1.067	1021	62	1.215	318	22	1.108	983	62	1.380	280
23	1.070	973	63	1.220	312	23	1.114	935	63	1.389	274
24	1.074	930	64	1.224	306	24	1.119	892	64	1.398	268
25	1.077	890	65	1.228	300	25	1.125	852	65	1.406	262
26	1.080	853	66	1.232	295	26	1.131	815	66	1.415	257
27	1.084	819	67	1.237	289	27	1.136	781	67	1.424	251
28	1.087	787	68	1.241	284	28	1.142	749	68	1.433	246
29	1.090	758	69	1.246	279	29	1.148	720	69	1.442	241
30	1.094	730	70	1.250	274	30	1.154	692	70	1.452	236
31	1.097	705	71	1.254	269	31	1.160	666	71	1.461	231
32	1.101	680	72	1.259	264	32	1.166	643	72	1.471	226
33	1.104	658	73	1.264	260	33	1.172	620	73	1.480	222
34	1.108	636	74	1.268	255	34	1.178	598	74	1.490	217
35	1.111	616	75	1.273	251	35	1.184	578	75	1.500	213
36	1.115	597	76	1.277	247	36	1.190	559	76	1.510	209
37	1.118	579	77	1.282	243	37	1.197	541	77	1.520	205
38	1.122	562	78	1.287	239	38	1.203	524	78	1.531	201
39	1.125	546	79	1.292	235	39	1.210	508	79	1.541	197
40	1.129	531	80	1.296	231	40	1.216	493	80	1.552	193

## Water and solids – Pulp density data

A = Solids by weight [%]

B = Pulp density [ton/m<sup>3</sup>]

C = Pulp volume [m<sup>3</sup>/ton solids]

Density of solids: 2.0						Density of solids: 2.6					
A	B	C	A	B	C	A	B	C	A	B	C
1	1.005	99.500	41	1.258	1.939	1	1.006	99.385	41	1.337	1.824
2	1.010	49.500	42	1.266	1.881	2	1.012	49.385	42	1.349	1.766
3	1.015	32.833	43	1.274	1.826	3	1.019	32.718	43	1.360	1.710
4	1.020	24.500	44	1.282	1.773	4	1.025	24.385	44	1.371	1.657
5	1.026	19.500	45	1.290	1.722	5	1.032	19.385	45	1.383	1.607
6	1.031	16.167	46	1.299	1.674	6	1.038	16.051	46	1.395	1.559
7	1.036	13.786	47	1.307	1.628	7	1.045	13.670	47	1.407	1.512
8	1.042	12.000	48	1.316	1.583	8	1.052	11.885	48	1.419	1.468
9	1.047	10.611	49	1.325	1.541	9	1.059	10.496	49	1.432	1.425
10	1.053	9.500	50	1.333	1.500	10	1.066	9.385	50	1.444	1.385
11	1.058	8.591	51	1.342	1.461	11	1.073	8.476	51	1.457	1.345
12	1.064	7.833	52	1.351	1.423	12	1.080	7.718	52	1.471	1.308
13	1.070	7.192	53	1.361	1.387	13	1.087	7.077	53	1.484	1.271
14	1.075	6.643	54	1.370	1.352	14	1.094	6.527	54	1.498	1.236
15	1.081	6.167	55	1.379	1.318	15	1.102	6.051	55	1.512	1.203
16	1.087	5.750	56	1.389	1.286	16	1.109	5.635	56	1.526	1.170
17	1.093	5.382	57	1.399	1.254	17	1.117	5.267	57	1.540	1.139
18	1.099	5.056	58	1.408	1.224	18	1.125	4.940	58	1.555	1.109
19	1.105	4.763	59	1.418	1.195	19	1.132	4.648	59	1.570	1.080
20	1.111	4.500	60	1.429	1.167	20	1.140	4.385	60	1.585	1.051
21	1.117	4.262	61	1.439	1.139	21	1.148	4.147	61	1.601	1.024
22	1.124	4.045	62	1.449	1.113	22	1.157	3.930	62	1.617	0.998
23	1.130	3.848	63	1.460	1.087	23	1.165	3.732	63	1.633	0.972
24	1.136	3.667	64	1.471	1.063	24	1.173	3.551	64	1.650	0.947
25	1.143	3.500	65	1.481	1.038	25	1.182	3.385	65	1.667	0.923
26	1.149	3.346	66	1.493	1.015	26	1.190	3.231	66	1.684	0.900
27	1.156	3.204	67	1.504	0.993	27	1.199	3.088	67	1.702	0.877
28	1.163	3.071	68	1.515	0.971	28	1.208	2.956	68	1.720	0.855
29	1.170	2.948	69	1.527	0.949	29	1.217	2.833	69	1.738	0.834
30	1.176	2.833	70	1.538	0.929	30	1.226	2.718	70	1.757	0.813
31	1.183	2.726	71	1.550	0.908	31	1.236	2.610	71	1.776	0.793
32	1.190	2.625	72	1.563	0.889	32	1.245	2.510	72	1.796	0.774
33	1.198	2.530	73	1.575	0.870	33	1.255	2.415	73	1.816	0.754
34	1.205	2.441	74	1.587	0.851	34	1.265	2.326	74	1.836	0.736
35	1.212	2.357	75	1.600	0.833	35	1.275	2.242	75	1.857	0.718
36	1.220	2.278	76	1.613	0.816	36	1.285	2.162	76	1.879	0.700
37	1.227	2.203	77	1.626	0.799	37	1.295	2.087	77	1.901	0.683
38	1.235	2.132	78	1.639	0.782	38	1.305	2.016	78	1.923	0.667
39	1.242	2.064	79	1.653	0.766	39	1.316	1.949	79	1.946	0.650
40	1.250	2.000	80	1.667	0.750	40	1.327	1.885	80	1.970	0.635



## Water and solids – Pulp density data (US)

A = Solids by weight [%]

B = Pulp S. G.

C = Pulp volume USG/ton solids

Density of solids: 2.0						Density of solids: 2.6					
A	B	C	A	B	C	A	B	C	A	B	C
1	1.005	23845	41	1.258	465	1	1.006	23818	41	1.337	437
2	1.010	11863	42	1.266	451	2	1.012	11835	42	1.349	423
3	1.015	7869	43	1.274	438	3	1.019	7841	43	1.360	410
4	1.020	5871	44	1.282	425	4	1.025	5844	44	1.371	397
5	1.026	4673	45	1.290	413	5	1.032	4646	45	1.383	385
6	1.031	3874	46	1.299	401	6	1.038	3847	46	1.395	374
7	1.036	3304	47	1.307	390	7	1.045	3276	47	1.407	362
8	1.042	2876	48	1.316	379	8	1.052	2848	48	1.419	352
9	1.047	2543	49	1.325	369	9	1.059	2515	49	1.432	342
10	1.053	2277	50	1.333	359	10	1.066	2249	50	1.444	332
11	1.058	2059	51	1.342	350	11	1.073	2031	51	1.457	322
12	1.064	1877	52	1.351	341	12	1.080	1850	52	1.471	313
13	1.070	1724	53	1.361	332	13	1.087	1696	53	1.484	305
14	1.075	1592	54	1.370	324	14	1.094	1564	54	1.498	296
15	1.081	1478	55	1.379	316	15	1.102	1450	55	1.512	288
16	1.087	1378	56	1.389	308	16	1.109	1350	56	1.526	280
17	1.093	1290	57	1.399	301	17	1.117	1262	57	1.540	273
18	1.099	1212	58	1.408	293	18	1.125	1184	58	1.555	266
19	1.105	1141	59	1.418	286	19	1.132	1114	59	1.570	259
20	1.111	1078	60	1.429	280	20	1.140	1051	60	1.585	252
21	1.117	1021	61	1.439	273	21	1.148	994	61	1.601	245
22	1.124	969	62	1.449	267	22	1.157	942	62	1.617	239
23	1.130	922	63	1.460	261	23	1.165	894	63	1.633	233
24	1.136	879	64	1.471	255	24	1.173	851	64	1.650	227
25	1.143	839	65	1.481	249	25	1.182	811	65	1.667	221
26	1.149	802	66	1.493	243	26	1.190	774	66	1.684	216
27	1.156	768	67	1.504	238	27	1.199	740	67	1.702	210
28	1.163	736	68	1.515	233	28	1.208	708	68	1.720	205
29	1.170	706	69	1.527	227	29	1.217	679	69	1.738	200
30	1.176	679	70	1.538	223	30	1.226	651	70	1.757	195
31	1.183	653	71	1.550	218	31	1.236	625	71	1.776	190
32	1.190	629	72	1.563	213	32	1.245	602	72	1.796	185
33	1.198	606	73	1.575	208	33	1.255	579	73	1.816	181
34	1.205	585	74	1.587	204	34	1.265	557	74	1.836	176
35	1.212	565	75	1.600	200	35	1.275	537	75	1.857	172
36	1.220	546	76	1.613	196	36	1.285	518	76	1.879	168
37	1.227	528	77	1.626	191	37	1.295	500	77	1.901	164
38	1.235	511	78	1.639	187	38	1.305	483	78	1.923	160
39	1.242	495	79	1.653	184	39	1.316	467	79	1.946	156
40	1.250	479	80	1.667	180	40	1.327	452	80	1.970	152

## Water and solids – Pulp density data

A = Solids by weight [%]

B = Pulp density [ton/m<sup>3</sup>]

C = Pulp volume [m<sup>3</sup>/ton solids]

Density of solids: 2.8						Density of solids: 3.0					
A	B	C	A	B	C	A	B	C	A	B	C
1	1.006	99.357	41	1.358	1.796	1	1.007	99.333	41	1.376	1.772
2	1.013	49.357	42	1.370	1.738	2	1.014	49.333	42	1.389	1.714
3	1.020	32.690	43	1.382	1.683	3	1.020	32.667	43	1.402	1.659
4	1.026	24.357	44	1.394	1.630	4	1.027	24.333	44	1.415	1.606
5	1.033	19.357	45	1.407	1.579	5	1.034	19.333	45	1.429	1.556
6	1.040	16.024	46	1.420	1.531	6	1.042	16.000	46	1.442	1.507
7	1.047	13.643	47	1.433	1.485	7	1.049	13.619	47	1.456	1.461
8	1.054	11.857	48	1.446	1.440	8	1.056	11.833	48	1.471	1.417
9	1.061	10.468	49	1.460	1.398	9	1.064	10.444	49	1.485	1.374
10	1.069	9.357	50	1.474	1.357	10	1.071	9.333	50	1.500	1.333
11	1.076	8.448	51	1.488	1.318	11	1.079	8.424	51	1.515	1.294
12	1.084	7.690	52	1.502	1.280	12	1.087	7.667	52	1.531	1.256
13	1.091	7.049	53	1.517	1.244	13	1.095	7.026	53	1.546	1.220
14	1.099	6.500	54	1.532	1.209	14	1.103	6.476	54	1.563	1.185
15	1.107	6.024	55	1.547	1.175	15	1.111	6.000	55	1.579	1.152
16	1.115	5.607	56	1.563	1.143	16	1.119	5.583	56	1.596	1.119
17	1.123	5.239	57	1.578	1.112	17	1.128	5.216	57	1.613	1.088
18	1.131	4.913	58	1.595	1.081	18	1.136	4.889	58	1.630	1.057
19	1.139	4.620	59	1.611	1.052	19	1.145	4.596	59	1.648	1.028
20	1.148	4.357	60	1.628	1.024	20	1.154	4.333	60	1.667	1.000
21	1.156	4.119	61	1.645	0.996	21	1.163	4.095	61	1.685	0.973
22	1.165	3.903	62	1.663	0.970	22	1.172	3.879	62	1.705	0.946
23	1.174	3.705	63	1.681	0.944	23	1.181	3.681	63	1.724	0.921
24	1.182	3.524	64	1.699	0.920	24	1.190	3.500	64	1.744	0.896
25	1.191	3.357	65	1.718	0.896	25	1.200	3.333	65	1.765	0.872
26	1.201	3.203	66	1.737	0.872	26	1.210	3.179	66	1.786	0.848
27	1.210	3.061	67	1.757	0.850	27	1.220	3.037	67	1.807	0.826
28	1.220	2.929	68	1.777	0.828	28	1.230	2.905	68	1.829	0.804
29	1.229	2.805	69	1.797	0.806	29	1.240	2.782	69	1.852	0.783
30	1.239	2.690	70	1.818	0.786	30	1.250	2.667	70	1.875	0.762
31	1.249	2.583	71	1.840	0.766	31	1.261	2.559	71	1.899	0.742
32	1.259	2.482	72	1.862	0.746	32	1.271	2.458	72	1.923	0.722
33	1.269	2.387	73	1.884	0.727	33	1.282	2.364	73	1.948	0.703
34	1.280	2.298	74	1.907	0.708	34	1.293	2.275	74	1.974	0.685
35	1.290	2.214	75	1.931	0.690	35	1.304	2.190	75	2.000	0.667
36	1.301	2.135	76	1.955	0.673	36	1.316	2.111	76	2.027	0.649
37	1.312	2.060	77	1.980	0.656	37	1.327	2.036	77	2.055	0.632
38	1.323	1.989	78	2.006	0.639	38	1.339	1.965	78	2.083	0.615
39	1.335	1.921	79	2.032	0.623	39	1.351	1.897	79	2.113	0.599
40	1.346	1.857	80	2.059	0.607	40	1.364	1.833	80	2.143	0.583

## Water and solids – Pulp density data (US)

A = Solids by weight [%]

B = Pulp density [ton/m<sup>3</sup>]

C = Pulp volume [m<sup>3</sup>/ton solids]

Density of solids: 2.8						Density of solids: 3.0					
A	B	C	A	B	C	A	B	C	A	B	C
1	1.006	23811	41	1.358	430	1	1.007	23805	41	1.376	425
2	1.013	11829	42	1.370	417	2	1.014	11823	42	1.389	411
3	1.020	7834	43	1.382	403	3	1.020	7829	43	1.402	398
4	1.026	5837	44	1.394	391	4	1.027	5831	44	1.415	385
5	1.033	4639	45	1.407	378	5	1.034	4633	45	1.429	373
6	1.040	3840	46	1.420	367	6	1.042	3834	46	1.442	361
7	1.047	3270	47	1.433	356	7	1.049	3264	47	1.456	350
8	1.054	2842	48	1.446	345	8	1.056	2836	48	1.471	340
9	1.061	2509	49	1.460	335	9	1.064	2503	49	1.485	329
10	1.069	2242	50	1.474	325	10	1.071	2237	50	1.500	319
11	1.076	2025	51	1.488	316	11	1.079	2019	51	1.515	310
12	1.084	1843	52	1.502	307	12	1.087	1837	52	1.531	301
13	1.091	1689	53	1.517	298	13	1.095	1684	53	1.546	292
14	1.099	1558	54	1.532	290	14	1.103	1552	54	1.563	284
15	1.107	1444	55	1.547	282	15	1.111	1438	55	1.579	276
16	1.115	1344	56	1.563	274	16	1.119	1338	56	1.596	268
17	1.123	1256	57	1.578	266	17	1.128	1250	57	1.613	261
18	1.131	1177	58	1.595	259	18	1.136	1172	58	1.630	253
19	1.139	1107	59	1.611	252	19	1.145	1101	59	1.648	246
20	1.148	1044	60	1.628	245	20	1.154	1038	60	1.667	240
21	1.156	987	61	1.645	239	21	1.163	981	61	1.685	233
22	1.165	935	62	1.663	232	22	1.172	930	62	1.705	227
23	1.174	888	63	1.681	226	23	1.181	882	63	1.724	221
24	1.182	845	64	1.699	220	24	1.190	839	64	1.744	215
25	1.191	805	65	1.718	215	25	1.200	799	65	1.765	209
26	1.201	768	66	1.737	209	26	1.210	762	66	1.786	203
27	1.210	734	67	1.757	204	27	1.220	728	67	1.807	198
28	1.220	702	68	1.777	198	28	1.230	696	68	1.829	193
29	1.229	672	69	1.797	193	29	1.240	667	69	1.852	188
30	1.239	645	70	1.818	188	30	1.250	639	70	1.875	183
31	1.249	619	71	1.840	184	31	1.261	613	71	1.899	178
32	1.259	595	72	1.862	179	32	1.271	589	72	1.923	173
33	1.269	572	73	1.884	174	33	1.282	567	73	1.948	168
34	1.280	551	74	1.907	170	34	1.293	545	74	1.974	164
35	1.290	531	75	1.931	165	35	1.304	525	75	2.000	160
36	1.301	512	76	1.955	161	36	1.316	506	76	2.027	156
37	1.312	494	77	1.980	157	37	1.327	488	77	2.055	151
38	1.323	477	78	2.006	153	38	1.339	471	78	2.083	147
39	1.335	460	79	2.032	149	39	1.351	455	79	2.113	144
40	1.346	445	80	2.059	145	40	1.364	439	80	2.143	140

## Water and solids – Pulp density data

A = Solids by weight [%]

B = Pulp density [ton/m<sup>3</sup>]

C = Pulp volume [m<sup>3</sup>/ton solids]

Density of solids: 3.2						Density of solids: 3.4					
A	B	C	A	B	C	A	B	C	A	B	C
1	1.007	99.313	41	1.393	1.752	1	1.007	99.294	41	1.407	1.733
2	1.014	49.313	42	1.406	1.693	2	1.014	49.294	42	1.421	1.675
3	1.021	32.646	43	1.420	1.638	3	1.022	32.627	43	1.436	1.620
4	1.028	24.313	44	1.434	1.585	4	1.029	24.294	44	1.451	1.567
5	1.036	19.313	45	1.448	1.535	5	1.037	19.294	45	1.466	1.516
6	1.043	15.979	46	1.463	1.486	6	1.044	15.961	46	1.481	1.468
7	1.051	13.598	47	1.477	1.440	7	1.052	13.580	47	1.496	1.422
8	1.058	11.813	48	1.493	1.396	8	1.060	11.794	48	1.512	1.377
9	1.066	10.424	49	1.508	1.353	9	1.068	10.405	49	1.529	1.335
10	1.074	9.313	50	1.524	1.313	10	1.076	9.294	50	1.545	1.294
11	1.082	8.403	51	1.540	1.273	11	1.084	8.385	51	1.563	1.255
12	1.090	7.646	52	1.556	1.236	12	1.093	7.627	52	1.580	1.217
13	1.098	7.005	53	1.573	1.199	13	1.101	6.986	53	1.598	1.181
14	1.107	6.455	54	1.590	1.164	14	1.110	6.437	54	1.616	1.146
15	1.115	5.979	55	1.608	1.131	15	1.118	5.961	55	1.635	1.112
16	1.124	5.563	56	1.626	1.098	16	1.127	5.544	56	1.654	1.080
17	1.132	5.195	57	1.644	1.067	17	1.136	5.176	57	1.673	1.049
18	1.141	4.868	58	1.663	1.037	18	1.146	4.850	58	1.693	1.018
19	1.150	4.576	59	1.682	1.007	19	1.155	4.557	59	1.714	0.989
20	1.159	4.313	60	1.702	0.979	20	1.164	4.294	60	1.735	0.961
21	1.169	4.074	61	1.722	0.952	21	1.174	4.056	61	1.756	0.933
22	1.178	3.858	62	1.743	0.925	22	1.184	3.840	62	1.778	0.907
23	1.188	3.660	63	1.764	0.900	23	1.194	3.642	63	1.801	0.881
24	1.198	3.479	64	1.786	0.875	24	1.204	3.461	64	1.824	0.857
25	1.208	3.313	65	1.808	0.851	25	1.214	3.294	65	1.848	0.833
26	1.218	3.159	66	1.831	0.828	26	1.225	3.140	66	1.872	0.809
27	1.228	3.016	67	1.854	0.805	27	1.235	2.998	67	1.897	0.787
28	1.238	2.884	68	1.878	0.783	28	1.246	2.866	68	1.923	0.765
29	1.249	2.761	69	1.902	0.762	29	1.257	2.742	69	1.950	0.743
30	1.260	2.646	70	1.928	0.741	30	1.269	2.627	70	1.977	0.723
31	1.271	2.538	71	1.954	0.721	31	1.280	2.520	71	2.005	0.703
32	1.282	2.438	72	1.980	0.701	32	1.292	2.419	72	2.033	0.683
33	1.293	2.343	73	2.008	0.682	33	1.304	2.324	73	2.063	0.664
34	1.305	2.254	74	2.036	0.664	34	1.316	2.235	74	2.094	0.645
35	1.317	2.170	75	2.065	0.646	35	1.328	2.151	75	2.125	0.627
36	1.329	2.090	76	2.094	0.628	36	1.341	2.072	76	2.157	0.610
37	1.341	2.015	77	2.125	0.611	37	1.354	1.997	77	2.191	0.593
38	1.354	1.944	78	2.156	0.595	38	1.367	1.926	78	2.225	0.576
39	1.366	1.877	79	2.189	0.578	39	1.380	1.858	79	2.261	0.560
40	1.379	1.813	80	2.222	0.563	40	1.393	1.794	80	2.297	0.544

## Water and solids – Pulp density data (US)

A = Solids by weight [%]

B = Pulp density [ton/m<sup>3</sup>]

C = Pulp volume [m<sup>3</sup>/ton solids]

Density of solids: 3.2						Density of solids: 3.4					
A	B	C	A	B	C	A	B	C	A	B	C
1	1.007	23801	41	1.393	420	1	1.007	23796	41	1.407	415
2	1.014	11818	42	1.406	406	2	1.014	11813	42	1.421	401
3	1.021	7824	43	1.420	393	3	1.022	7819	43	1.436	388
4	1.028	5827	44	1.434	380	4	1.029	5822	44	1.451	376
5	1.036	4628	45	1.448	368	5	1.037	4624	45	1.466	363
6	1.043	3829	46	1.463	356	6	1.044	3825	46	1.481	352
7	1.051	3259	47	1.477	345	7	1.052	3254	47	1.496	341
8	1.058	2831	48	1.493	335	8	1.060	2826	48	1.512	330
9	1.066	2498	49	1.508	324	9	1.068	2494	49	1.529	320
10	1.074	2232	50	1.524	315	10	1.076	2227	50	1.545	310
11	1.082	2014	51	1.540	305	11	1.084	2009	51	1.563	301
12	1.090	1832	52	1.556	296	12	1.093	1828	52	1.580	292
13	1.098	1679	53	1.573	287	13	1.101	1674	53	1.598	283
14	1.107	1547	54	1.590	279	14	1.110	1543	54	1.616	275
15	1.115	1433	55	1.608	271	15	1.118	1429	55	1.635	266
16	1.124	1333	56	1.626	263	16	1.127	1329	56	1.654	259
17	1.132	1245	57	1.644	256	17	1.136	1240	57	1.673	251
18	1.141	1167	58	1.663	249	18	1.146	1162	58	1.693	244
19	1.150	1097	59	1.682	241	19	1.155	1092	59	1.714	237
20	1.159	1034	60	1.702	235	20	1.164	1029	60	1.735	230
21	1.169	976	61	1.722	228	21	1.174	972	61	1.756	224
22	1.178	925	62	1.743	222	22	1.184	920	62	1.778	217
23	1.188	877	63	1.764	216	23	1.194	873	63	1.801	211
24	1.198	834	64	1.786	210	24	1.204	829	64	1.824	205
25	1.208	794	65	1.808	204	25	1.214	789	65	1.848	200
26	1.218	757	66	1.831	198	26	1.225	753	66	1.872	194
27	1.228	723	67	1.854	193	27	1.235	718	67	1.897	189
28	1.238	691	68	1.878	188	28	1.246	687	68	1.923	183
29	1.249	662	69	1.902	183	29	1.257	657	69	1.950	178
30	1.260	634	70	1.928	178	30	1.269	630	70	1.977	173
31	1.271	608	71	1.954	173	31	1.280	604	71	2.005	168
32	1.282	584	72	1.980	168	32	1.292	580	72	2.033	164
33	1.293	562	73	2.008	163	33	1.304	557	73	2.063	159
34	1.305	540	74	2.036	159	34	1.316	536	74	2.094	155
35	1.317	520	75	2.065	155	35	1.328	515	75	2.125	150
36	1.329	501	76	2.094	151	36	1.341	497	76	2.157	146
37	1.341	483	77	2.125	146	37	1.354	479	77	2.191	142
38	1.354	466	78	2.156	143	38	1.367	462	78	2.225	138
39	1.366	450	79	2.189	139	39	1.380	445	79	2.261	134
40	1.379	434	80	2.222	135	40	1.393	430	80	2.297	130

## Water and solids – Pulp density data

A = Solids by weight [%]

B = Pulp density [ton/m<sup>3</sup>]

C = Pulp volume [m<sup>3</sup>/ton solids]

Density of solids: 3.6						Density of solids: 3.8					
A	B	C	A	B	C	A	B	C	A	B	C
1	1.007	99.278	41	1.421	1.717	1	1.007	99.263	41	1.433	1.702
2	1.015	49.278	42	1.435	1.659	2	1.015	49.263	42	1.448	1.644
3	1.022	32.611	43	1.450	1.603	3	1.023	32.596	43	1.464	1.589
4	1.030	24.278	44	1.466	1.551	4	1.030	24.263	44	1.480	1.536
5	1.037	19.278	45	1.481	1.500	5	1.038	19.263	45	1.496	1.485
6	1.045	15.944	46	1.498	1.452	6	1.046	15.930	46	1.513	1.437
7	1.053	13.563	47	1.514	1.405	7	1.054	13.549	47	1.530	1.391
8	1.061	11.778	48	1.531	1.361	8	1.063	11.763	48	1.547	1.346
9	1.070	10.389	49	1.548	1.319	9	1.071	10.374	49	1.565	1.304
10	1.078	9.278	50	1.565	1.278	10	1.080	9.263	50	1.583	1.263
11	1.086	8.369	51	1.583	1.239	11	1.088	8.354	51	1.602	1.224
12	1.095	7.611	52	1.601	1.201	12	1.097	7.596	52	1.621	1.186
13	1.104	6.970	53	1.620	1.165	13	1.106	6.955	53	1.641	1.150
14	1.112	6.421	54	1.639	1.130	14	1.115	6.406	54	1.661	1.115
15	1.121	5.944	55	1.659	1.096	15	1.124	5.930	55	1.681	1.081
16	1.131	5.528	56	1.679	1.063	16	1.134	5.513	56	1.703	1.049
17	1.140	5.160	57	1.700	1.032	17	1.143	5.146	57	1.724	1.018
18	1.149	4.833	58	1.721	1.002	18	1.153	4.819	58	1.746	0.987
19	1.159	4.541	59	1.742	0.973	19	1.163	4.526	59	1.769	0.958
20	1.169	4.278	60	1.765	0.944	20	1.173	4.263	60	1.792	0.930
21	1.179	4.040	61	1.787	0.917	21	1.183	4.025	61	1.816	0.903
22	1.189	3.823	62	1.811	0.891	22	1.193	3.809	62	1.841	0.876
23	1.199	3.626	63	1.835	0.865	23	1.204	3.611	63	1.866	0.850
24	1.210	3.444	64	1.860	0.840	24	1.215	3.430	64	1.892	0.826
25	1.220	3.278	65	1.885	0.816	25	1.226	3.263	65	1.919	0.802
26	1.231	3.124	66	1.911	0.793	26	1.237	3.109	66	1.947	0.778
27	1.242	2.981	67	1.938	0.770	27	1.248	2.967	67	1.975	0.756
28	1.253	2.849	68	1.965	0.748	28	1.260	2.835	68	2.004	0.734
29	1.265	2.726	69	1.993	0.727	29	1.272	2.711	69	2.034	0.712
30	1.277	2.611	70	2.022	0.706	30	1.284	2.596	70	2.065	0.692
31	1.288	2.504	71	2.052	0.686	31	1.296	2.489	71	2.097	0.672
32	1.301	2.403	72	2.083	0.667	32	1.309	2.388	72	2.130	0.652
33	1.313	2.308	73	2.115	0.648	33	1.321	2.293	73	2.164	0.633
34	1.325	2.219	74	2.148	0.629	34	1.334	2.204	74	2.199	0.615
35	1.338	2.135	75	2.182	0.611	35	1.348	2.120	75	2.235	0.596
36	1.351	2.056	76	2.217	0.594	36	1.361	2.041	76	2.273	0.579
37	1.365	1.980	77	2.253	0.576	37	1.375	1.966	77	2.311	0.562
38	1.378	1.909	78	2.290	0.560	38	1.389	1.895	78	2.351	0.545
39	1.392	1.842	79	2.329	0.544	39	1.403	1.827	79	2.393	0.529
40	1.406	1.778	80	2.368	0.528	40	1.418	1.763	80	2.436	0.513

## Water and solids – Pulp density data (US)

A = Solids by weight [%]

B = Pulp density [ton/m<sup>3</sup>]

C = Pulp volume [m<sup>3</sup>/ton solids]

Density of solids: 3.6						Density of solids: 3.8					
A	B	C	A	B	C	A	B	C	A	B	C
1	1.007	23792	41	1.421	411	1	1.007	23789	41	1.433	408
2	1.015	11810	42	1.435	398	2	1.015	11806	42	1.448	394
3	1.022	7815	43	1.450	384	3	1.023	7812	43	1.464	381
4	1.030	5818	44	1.466	372	4	1.030	5815	44	1.480	368
5	1.037	4620	45	1.481	359	5	1.038	4616	45	1.496	356
6	1.045	3821	46	1.498	348	6	1.046	3818	46	1.513	344
7	1.053	3250	47	1.514	337	7	1.054	3247	47	1.530	333
8	1.061	2823	48	1.531	326	8	1.063	2819	48	1.547	323
9	1.070	2490	49	1.548	316	9	1.071	2486	49	1.565	313
10	1.078	2223	50	1.565	306	10	1.080	2220	50	1.583	303
11	1.086	2006	51	1.583	297	11	1.088	2002	51	1.602	293
12	1.095	1824	52	1.601	288	12	1.097	1820	52	1.621	284
13	1.104	1670	53	1.620	279	13	1.106	1667	53	1.641	276
14	1.112	1539	54	1.639	271	14	1.115	1535	54	1.661	267
15	1.121	1424	55	1.659	263	15	1.124	1421	55	1.681	259
16	1.131	1325	56	1.679	255	16	1.134	1321	56	1.703	251
17	1.140	1237	57	1.700	247	17	1.143	1233	57	1.724	244
18	1.149	1158	58	1.721	240	18	1.153	1155	58	1.746	237
19	1.159	1088	59	1.742	233	19	1.163	1085	59	1.769	230
20	1.169	1025	60	1.765	226	20	1.173	1022	60	1.792	223
21	1.179	968	61	1.787	220	21	1.183	965	61	1.816	216
22	1.189	916	62	1.811	214	22	1.193	913	62	1.841	210
23	1.199	869	63	1.835	207	23	1.204	865	63	1.866	204
24	1.210	825	64	1.860	201	24	1.215	822	64	1.892	198
25	1.220	786	65	1.885	196	25	1.226	782	65	1.919	192
26	1.231	749	66	1.911	190	26	1.237	745	66	1.947	186
27	1.242	714	67	1.938	185	27	1.248	711	67	1.975	181
28	1.253	683	68	1.965	179	28	1.260	679	68	2.004	176
29	1.265	653	69	1.993	174	29	1.272	650	69	2.034	171
30	1.277	626	70	2.022	169	30	1.284	622	70	2.065	166
31	1.288	600	71	2.052	164	31	1.296	596	71	2.097	161
32	1.301	576	72	2.083	160	32	1.309	572	72	2.130	156
33	1.313	553	73	2.115	155	33	1.321	550	73	2.164	152
34	1.325	532	74	2.148	151	34	1.334	528	74	2.199	147
35	1.338	512	75	2.182	146	35	1.348	508	75	2.235	143
36	1.351	493	76	2.217	142	36	1.361	489	76	2.273	139
37	1.365	475	77	2.253	138	37	1.375	471	77	2.311	135
38	1.378	457	78	2.290	134	38	1.389	454	78	2.351	131
39	1.392	441	79	2.329	130	39	1.403	438	79	2.393	127
40	1.406	426	80	2.368	127	40	1.418	423	80	2.436	123

## Water and solids – Pulp density data

A = Solids by weight [%]

B = Pulp density [ton/m<sup>3</sup>]

C = Pulp volume [m<sup>3</sup>/ton solids]

Density of solids: 4.2						Density of solids: 4.6					
A	B	C	A	B	C	A	B	C	A	B	C
1	1.008	99.238	41	1.454	1.677	1	1.008	99.217	41	1.472	1.656
2	1.015	49.238	42	1.471	1.619	2	1.016	49.217	42	1.490	1.598
3	1.023	32.571	43	1.487	1.564	3	1.024	32.551	43	1.507	1.543
4	1.031	24.238	44	1.504	1.511	4	1.032	24.217	44	1.525	1.490
5	1.040	19.238	45	1.522	1.460	5	1.041	19.217	45	1.544	1.440
6	1.048	15.905	46	1.540	1.412	6	1.049	15.884	46	1.563	1.391
7	1.056	13.524	47	1.558	1.366	7	1.058	13.503	47	1.582	1.345
8	1.065	11.738	48	1.577	1.321	8	1.067	11.717	48	1.602	1.301
9	1.074	10.349	49	1.596	1.279	9	1.076	10.329	49	1.622	1.258
10	1.082	9.238	50	1.615	1.238	10	1.085	9.217	50	1.643	1.217
11	1.091	8.329	51	1.636	1.199	11	1.094	8.308	51	1.664	1.178
12	1.101	7.571	52	1.656	1.161	12	1.104	7.551	52	1.686	1.140
13	1.110	6.930	53	1.677	1.125	13	1.113	6.910	53	1.709	1.104
14	1.119	6.381	54	1.699	1.090	14	1.123	6.360	54	1.732	1.069
15	1.129	5.905	55	1.721	1.056	15	1.133	5.884	55	1.756	1.036
16	1.139	5.488	56	1.744	1.024	16	1.143	5.467	56	1.780	1.003
17	1.149	5.120	57	1.768	0.992	17	1.153	5.100	57	1.805	0.972
18	1.159	4.794	58	1.792	0.962	18	1.164	4.773	58	1.831	0.942
19	1.169	4.501	59	1.817	0.933	19	1.175	4.481	59	1.858	0.912
20	1.180	4.238	60	1.842	0.905	20	1.186	4.217	60	1.885	0.884
21	1.190	4.000	61	1.868	0.877	21	1.197	3.979	61	1.913	0.857
22	1.201	3.784	62	1.895	0.851	22	1.208	3.763	62	1.943	0.830
23	1.212	3.586	63	1.923	0.825	23	1.220	3.565	63	1.973	0.805
24	1.224	3.405	64	1.952	0.801	24	1.231	3.384	64	2.003	0.780
25	1.235	3.238	65	1.981	0.777	25	1.243	3.217	65	2.035	0.756
26	1.247	3.084	66	2.011	0.753	26	1.255	3.064	66	2.068	0.733
27	1.259	2.942	67	2.043	0.731	27	1.268	2.921	67	2.102	0.710
28	1.271	2.810	68	2.075	0.709	28	1.281	2.789	68	2.138	0.688
29	1.284	2.686	69	2.108	0.687	29	1.294	2.666	69	2.174	0.667
30	1.296	2.571	70	2.143	0.667	30	1.307	2.551	70	2.212	0.646
31	1.309	2.464	71	2.178	0.647	31	1.320	2.443	71	2.250	0.626
32	1.322	2.363	72	2.215	0.627	32	1.334	2.342	72	2.291	0.606
33	1.336	2.268	73	2.253	0.608	33	1.348	2.248	73	2.333	0.587
34	1.350	2.179	74	2.293	0.589	34	1.363	2.159	74	2.376	0.569
35	1.364	2.095	75	2.333	0.571	35	1.377	2.075	75	2.421	0.551
36	1.378	2.016	76	2.376	0.554	36	1.392	1.995	76	2.468	0.533
37	1.393	1.941	77	2.419	0.537	37	1.408	1.920	77	2.516	0.516
38	1.408	1.870	78	2.465	0.520	38	1.423	1.849	78	2.567	0.499
39	1.423	1.802	79	2.512	0.504	39	1.439	1.781	79	2.620	0.483
40	1.438	1.738	80	2.561	0.488	40	1.456	1.717	80	2.674	0.467



## Water and solids – Pulp density data (US)

A = Solids by weight [%]

B = Pulp density [ton/m<sup>3</sup>]

C = Pulp volume [m<sup>3</sup>/ton solids]

Density of solids: 4.2						Density of solids: 4.6					
A	B	C	A	B	C	A	B	C	A	B	C
1	1.008	23783	41	1.454	402	1	1.008	23778	41	1.472	397
2	1.015	11800	42	1.471	388	2	1.016	11795	42	1.490	383
3	1.023	7806	43	1.487	375	3	1.024	7801	43	1.507	370
4	1.031	5809	44	1.504	362	4	1.032	5804	44	1.525	357
5	1.040	4610	45	1.522	350	5	1.041	4605	45	1.544	345
6	1.048	3812	46	1.540	338	6	1.049	3807	46	1.563	333
7	1.056	3241	47	1.558	327	7	1.058	3236	47	1.582	322
8	1.065	2813	48	1.577	317	8	1.067	2808	48	1.602	312
9	1.074	2480	49	1.596	307	9	1.076	2475	49	1.622	301
10	1.082	2214	50	1.615	297	10	1.085	2209	50	1.643	292
11	1.091	1996	51	1.636	287	11	1.094	1991	51	1.664	282
12	1.101	1814	52	1.656	278	12	1.104	1810	52	1.686	273
13	1.110	1661	53	1.677	270	13	1.113	1656	53	1.709	265
14	1.119	1529	54	1.699	261	14	1.123	1524	54	1.732	256
15	1.129	1415	55	1.721	253	15	1.133	1410	55	1.756	248
16	1.139	1315	56	1.744	245	16	1.143	1310	56	1.780	240
17	1.149	1227	57	1.768	238	17	1.153	1222	57	1.805	233
18	1.159	1149	58	1.792	231	18	1.164	1144	58	1.831	226
19	1.169	1079	59	1.817	224	19	1.175	1074	59	1.858	219
20	1.180	1016	60	1.842	217	20	1.186	1011	60	1.885	212
21	1.190	959	61	1.868	210	21	1.197	954	61	1.913	205
22	1.201	907	62	1.895	204	22	1.208	902	62	1.943	199
23	1.212	859	63	1.923	198	23	1.220	854	63	1.973	193
24	1.224	816	64	1.952	192	24	1.231	811	64	2.003	187
25	1.235	776	65	1.981	186	25	1.243	771	65	2.035	181
26	1.247	739	66	2.011	180	26	1.255	734	66	2.068	176
27	1.259	705	67	2.043	175	27	1.268	700	67	2.102	170
28	1.271	673	68	2.075	170	28	1.281	668	68	2.138	165
29	1.284	644	69	2.108	165	29	1.294	639	69	2.174	160
30	1.296	616	70	2.143	160	30	1.307	611	70	2.212	155
31	1.309	591	71	2.178	155	31	1.320	585	71	2.250	150
32	1.322	566	72	2.215	150	32	1.334	561	72	2.291	145
33	1.336	544	73	2.253	146	33	1.348	539	73	2.333	141
34	1.350	522	74	2.293	141	34	1.363	517	74	2.376	136
35	1.364	502	75	2.333	137	35	1.377	497	75	2.421	132
36	1.378	483	76	2.376	133	36	1.392	478	76	2.468	128
37	1.393	465	77	2.419	129	37	1.408	460	77	2.516	124
38	1.408	448	78	2.465	125	38	1.423	443	78	2.567	120
39	1.423	432	79	2.512	121	39	1.439	427	79	2.620	116
40	1.438	417	80	2.561	117	40	1.456	411	80	2.674	112

## Water and solids – Pulp density data

A = Solids by weight [%]

B = Pulp density [ton/m<sup>3</sup>]

C = Pulp volume [m<sup>3</sup>/ton solids]

Density of solids: 5.0					
A	B	C	A	B	C
1	1.008	99.200	41	1.488	1.639
2	1.016	49.200	42	1.506	1.581
3	1.025	32.533	43	1.524	1.526
4	1.033	24.200	44	1.543	1.473
5	1.042	19.200	45	1.563	1.422
6	1.050	15.867	46	1.582	1.374
7	1.059	13.486	47	1.603	1.328
8	1.068	11.700	48	1.623	1.283
9	1.078	10.311	49	1.645	1.241
10	1.087	9.200	50	1.667	1.200
11	1.096	8.291	51	1.689	1.161
12	1.106	7.533	52	1.712	1.123
13	1.116	6.892	53	1.736	1.087
14	1.126	6.343	54	1.761	1.052
15	1.136	5.867	55	1.786	1.018
16	1.147	5.450	56	1.812	0.986
17	1.157	5.082	57	1.838	0.954
18	1.168	4.756	58	1.866	0.924
19	1.179	4.463	59	1.894	0.895
20	1.190	4.200	60	1.923	0.867
21	1.202	3.962	61	1.953	0.839
22	1.214	3.745	62	1.984	0.813
23	1.225	3.548	63	2.016	0.787
24	1.238	3.367	64	2.049	0.763
25	1.250	3.200	65	2.083	0.738
26	1.263	3.046	66	2.119	0.715
27	1.276	2.904	67	2.155	0.693
28	1.289	2.771	68	2.193	0.671
29	1.302	2.648	69	2.232	0.649
30	1.316	2.533	70	2.273	0.629
31	1.330	2.426	71	2.315	0.608
32	1.344	2.325	72	2.358	0.589
33	1.359	2.230	73	2.404	0.570
34	1.374	2.141	74	2.451	0.551
35	1.389	2.057	75	2.500	0.533
36	1.404	1.978	76	2.551	0.516
37	1.420	1.903	77	2.604	0.499
38	1.437	1.832	78	2.660	0.482
39	1.453	1.764	79	2.717	0.466
40	1.471	1.700	80	2.778	0.450

## Water and solids – Pulp density data (US)

A = Solids by weight [%]

B = Pulp density [ton/m<sup>3</sup>]

C = Pulp volume [m<sup>3</sup>/ton solids]

Density of solids: 5.0					
A	B	C	A	B	C
1	1.008	23774	41	1.488	393
2	1.016	11791	42	1.506	379
3	1.025	7797	43	1.524	366
4	1.033	5800	44	1.543	353
5	1.042	4601	45	1.563	341
6	1.050	3803	46	1.582	329
7	1.059	3232	47	1.603	318
8	1.068	2804	48	1.623	307
9	1.078	2471	49	1.645	297
10	1.087	2205	50	1.667	288
11	1.096	1987	51	1.689	278
12	1.106	1805	52	1.712	269
13	1.116	1652	53	1.736	261
14	1.126	1520	54	1.761	252
15	1.136	1406	55	1.786	244
16	1.147	1306	56	1.812	236
17	1.157	1218	57	1.838	229
18	1.168	1140	58	1.866	221
19	1.179	1070	59	1.894	214
20	1.190	1007	60	1.923	208
21	1.202	950	61	1.953	201
22	1.214	897	62	1.984	195
23	1.225	850	63	2.016	189
24	1.238	807	64	2.049	183
25	1.250	767	65	2.083	177
26	1.263	730	66	2.119	171
27	1.276	696	67	2.155	166
28	1.289	664	68	2.193	161
29	1.302	635	69	2.232	156
30	1.316	607	70	2.273	151
31	1.330	581	71	2.315	146
32	1.344	557	72	2.358	141
33	1.359	534	73	2.404	137
34	1.374	513	74	2.451	132
35	1.389	493	75	2.500	128
36	1.404	474	76	2.551	124
37	1.420	456	77	2.604	120
38	1.437	439	78	2.660	116
39	1.453	423	79	2.717	112
40	1.471	407	80	2.778	108

# 31. Chemical resistance tables

## Elastomer materials

Medium	Natural rubber	Butyl	EPDM	Nitrile	Chloro-prene	CSM* Hypalone	Poly-urethane
Aluminium chloride	A	A	A	A	A	A	A
Aluminium phosphate	A	A	A	A	A	A	A
Ammonium nitrate	C	A	A	A	B	A	U
Animal fats	U	B	B	A	B	B	A
Beef sugar liquors	A	A	A	A	A	A	
Bleach solution	U	A	A		C	A	
Brine			A	A	A	A	
Bunker oil				A			B
Calcium hydroxide	A	A	A	A	A	A	A
Calcium hypochlorite	U	A	A	C	C	A	
Chlorine (wet)	U	C	C		U	C	U
Chromium plating solutions	U	U	U	U	U	C	U
Copper chloride	A	A	A	A	A	A	A
Copper cyanide	A	A	A	A	A	A	A
Copper sulfate	B	A	A	A	A	A	A
Creosote	U	U	U	B	C	C	B
Detergent solutions	B	A	A	A	A	A	U
Diesel oil	U	U	U	A	B	B	B
Fatty acids	C	U	U	B	B	B	
Ferric chloride	A	A	A	A	A	A	A
Ferric nitrate	A	A	A	A	A	A	
Ferric sulfate	A	A	A	A	A	A	
Fluorosilic acid	A			A	A	A	
Fuel oil	U	U	U	A	B	B	B
Gasoline	U	U	U	A	B	B	A
Glycerine	A	A	A	A	A	A	A
Glycols	A	A	A	A	A	A	B
Hydraulic oil (Petroleum)	U	U	U	A	B	B	A
Hydrochloric acid (Hot 37 %)	U	C	C	U	U	C	U
Hydrochloric acid (Cold 37 %)	B	A	A	B	B	A	U
Hydrofluoric acid (Conc) cold	U	B	B	U	B	A	U
Hydrofluoric acid (Anhydrous)	U	B	B			A	
Hydrogen peroxide (90 %)	U	C	C	U		C	
Kerosene	U	U	U	A	C	C	B
Lacquers	U	U	U	U	U	U	U
Lacquers solvents	U	U	U	U	U	U	U
Lead acetate		A	A	B	B		
Lubrication oils (Petroleum)	U	U	U	A	B	B	B
Lye	B	A	A	B	B	A	B
Magnesium chloride	A	A	A	A	A	A	A
Mineral oil	U	U	U	A	B	B	A
Naphtha	U	U	U	C	C	U	C
Nickel chloride	A	A	A	A		A	A
Nickel sulfate	B	A	A	A	A	A	A

Medium	Natural rubber	Butyl	EPDM	Nitrile	Chloro-prene	CSM* Hypalone	Poly-urethane
Nitric acid conc.	U	C	C	U	C	B	U
Nitric acid dilute	U	B	B	U	A	A	C
Olive oil	U	B	B	A	B	B	A
Phosphoric acid 20 %	C	A	A	B	B	A	A
Pickling solution		C	C			C	
Pine oil	U	U	U	B	U	U	
Potassium carbonate	B	B	B	B	B	B	
Salt water	A	A	A	A	A	A	
Sewage	B	B	B	A	A	A	U
Silicone greases	A	A	A	A	A	A	A
Silicone oils	A	A	A	A	A	A	A
Soda ash	A	A	A	A	A	A	
Sodium bisulfite	B	A	A	A	A	A	
Sulfite liquors	B	B	B	B	B	B	
Sulfuric acid (Dilute)	C	B	B	U	B	A	B
Sulfuric acid (Conc)	U	B	B	U	U	B	U
Tar bituminous	U	U	U	B	C	C	
Transformer oil	U	U	U	A	B	B	
Transmission fluid type A	U	U	U	A	B	B	A
Trichloroethylene	U	U	U	C	U	U	U

\*= Chlorosulphonyl-polyethylene A = Recommended - little or no effect B = Minor to moderate effect C = Moderate to severe effect U = Not recommended

## High chromium

Centigrade	20°	60°	100°
Aluminium sulphite	U	U	U
Ammonia, anhydrous	A	A	A
Ammonia, aqueous	A	A	A
Ammonium chloride	A		
Aqua regia	U	U	U
Aromatic solvents	A	A	A
Brines, saturated	U	U	U
Bromide (K) soin.	U	U	U
Calcium chloride	U	U	U
Carbon disulphide	A	A	A
Carbonic acid	A	A	A
Caustic soda & potash	A	A	A
Cellulose paint	No data		
Chlorates of Na, K, Ba	No data		
Chlorine wet	U	U	U
Chlorides of Na, K, Mg	U	U	U
Copper sulphate	U	U	U
Emulsifiers (all conc.)	U	U	U
Ether	A	A	A
Fatty acids (<Cb)	A	A	A
Ferrous sulphate	A	A	A
Fluorine, wet	U	U	U
Fluorosilic acid	U	U	U
Hydrochloric acid (10%)	U	U	U
Hydrochloric acid (conc.)	U	U	U
Hydrofluoric acid (40%)	U	U	U
Hydrofluoric acid (75%)	U	U	U
Hydrogen sulphide	A	A	A
Hypochlorites	A	B	C
Hypochlorite (Na 12-14%)	A	No data	No data
Lead acetate	A	A	C
Lime (CaO)	A	A	A
Methanol	A	A	A
Milk and its products	A	B	B
Molasses	A	A	A
Naphtha	A	A	A
Naphthalene	A	A	A
Nickel salts	U	U	U
Nitrates of Na, K, NH3	A	A	A
Nitric acid (<25%)	A	A	C
Nitric acid (50%)	A	A	C
Nitric acid (90%)	A	A	C
Nitric acid, fuming	A	B	C
Nitrite (Na)	A	A	A
Oil, diesel	A	A	A
Oils, essential	A	A	A
Oils, lube + aromatic ads.	A	A	A
Oils, mineral	A	A	A
Oils, vegetable & animal	A	A	A
Petroleum spirits	A	A	A
Phenol	A	A	A

Centigrade	20°	60°	100°
Phosphoric acid (20%)	U	U	U
Phosphorous chlorides	U	U	U
Piperic acid	A	B	C
Sea water	A	A	B
Sodium carbonate	A	A	A
Sodium silicate	A	A	A
Sodium sulphide	U	U	U
Stannic chloride	U	U	U
Starch	A	A	A
Sugar spin, syrups, jams	A	A	A
Sulphates (Na, K, Mg, Ca)	A	A	A
Sulphites	A	A	A
Sulphur	A	A	A
Sulphur dioxide, dry	A	A	A
Sulphur dioxide, wet	A	B	C
Sulphur dioxide (96%)	U	U	U
Sulphur trioxide	U	U	U
Sulphuric acid (<50%)	U	U	U
Sulphur chlorides	U	U	U
Tallow	A	A	A
Tannic acid (10%)	A	A	A
Wetting agents (to 5%)	A	A	A
Zinc chloride	U	U	U

A = Recommended - little or no effect B = Minor to moderate effect C = Moderate to severe effect U = Not recommended













Pumps information at  
[www.metso.com/pumps](http://www.metso.com/pumps)

# Metso:Outotec

## **Metso Corporation**

Töölönlahdenkatu 2, FI-00100 Helsinki, Finland, [www.metso.com](http://www.metso.com)

Edition 8, 2020. Price € 15. English.

Information in this document is subject to change without notice. No part of this document may be reproduced in any form without the permission of Metso Outotec.

© Metso Outotec 2020. All rights reserved.